

rotork



Pakscan IIS Master Station Technical Manual

Software Level:

This manual relates to Pakscan IIS master stations fitted with software versions

V25 processor: 5222-020 V3.0 or later and

Loop card processor: 5206-034 V5.2 or later

As we are continually developing our products their design is subject to change without notice.

© The contents of this document are copyright and must not be reproduced without the written permission of Rotork Controls Ltd.

The name Rotork is a registered trademark

Modbus is a registered trademark of Modicon

Windows is a registered trademark of Microsoft Corporation.

Contents

How to use this Manual	9
Software level	9
1 INTRODUCTION.....	11
1.1 Related Documents.....	11
2 EQUIPMENT DESCRIPTION	13
3 STORAGE PROCEDURE.....	15
4 OVERVIEW OF PAKSCAN	17
4.1 Field Control Units	17
4.2 Control and Indication	17
FUNCTIONS.....	19
5.1 Cable Fault Protection – Loopback System	19
5.2 Current Loop Operations	19
5.2.1 Loop Configuration	19
5.2.2 Normal Operation	20
5.3 Modbus Serial Interfaces.....	20
5.4 Local User Interface (LCD and Keypad)	21
6 INITIAL SETTING UP	23
6.1 Jumper and Link Settings	23
6.2 Using S1, S2 and S3 to set Port 1 and 2 RS485 line options.....	26
6.3 External Links - ESD (Emergency Shut-down)	26
6.4 Display Screen Contrast.....	26
INSTALLATION AND CONNECTION.....	27
7.1 Mounting	27
7.2 Power.....	27
7.3 Field Wiring.....	27
7.3.1 Screen Connections	27
7.4 Loop Checks.....	29

7.4.1	Loop Continuity	29
7.4.2	Screen Continuity	30
7.4.3	Cable Capacitance	30
8	LCD AND KEYPAD	31
8.1	Keypad Security	31
8.1.1	Using a PIN	32
8.2	Menu Structure	32
8.3	Master Station Status	36
8.3.1	Master Station Commands	37
8.4	Configuration Mode Screen	38
8.5	Diagnostic Menus	39
	Top Diagnostic Display	39
8.5.2	Modbus Port Diagnostic Displays	40
8.5.3	Peer to Peer port diagnostic display	41
8.5.3.1	Peer Map Display	41
8.5.4	Loop Diagnostic Display	42
8.5.5	FCU Map and Failure Counts	44
8.5.6	Loop Speed Test	45
8.5.7	FCU Address Fault Details	46
8.6	Setup Menus	47
8.6.1	Top Setup Menu	47
8.6.2	Port Setup Menus	48
8.6.2.1	Alarm Linkage	49
8.6.3	Loop Setup Menu	50
8.6.3.1	Further Loop Options	51
8.6.4	Unit Address Setup Menu	52
8.6.5	Tag Setup Menu	53
8.6.6	Date and Time Setup	54
8.6.7	ESD Options Setup Menu	55
8.6.8	Keypad Security Options	56
8.7	Field Unit Menus	57
8.7.1	Actuator Field Unit Status Display	57
8.7.2	IQ Actuator Second Status Page	58

8.7.3	IQ Historic Torque Displays.....	59
8.7.4	Flowpak Actuator Field Unit Status Display.....	60
8.7.5	General Purpose Field Unit Status Display.....	61
8.7.5.1	Second Page for General Purpose Field Unit.....	62
8.7.6	IQ Analogue Input Field Unit.....	63
8.7.7	Communications Failure Display.....	64
8.7.8	Field Unit Status Secondary Data.....	65
8.8	Sequence and Interlock Menus.....	66
8.8.1	Sequence Information.....	67
8.8.2	Sequence Data.....	68
8.8.3	Interlock Data.....	69
8.8.4	Peer Data.....	70
9	SETTING PARAMETERS AND DOWNLOADING PROGRAMMES.....	71
9.1	Initial Decisions.....	71
9.2	Communication Ports.....	72
9.3	Loop Data.....	73
9.4	Tag Names.....	74
9.5	Date and Time.....	74
9.6	ESD Configuration.....	75
9.7	Security Access Level.....	75
9.8	Final Checks.....	75
9.9	Downloading Sequence Programmes.....	76
10	COMMISSIONING THE SYSTEM.....	77
10.1	Checking Individual Field Units.....	77
10.2	Checking the Loop Itself.....	78
10.3	Checking System Performance.....	80
10.3.1	Setting the Loop Driver Voltages.....	80
10.4	Setting Up Peer to Peer Communications.....	81
10.4.1	Connections.....	82
10.4.2	Hardware Setup.....	82
10.4.3	Software Setup.....	82
10.5	Setting Up Port 1 and 2 for RS232 or RS485 Communications.....	82
10.5.1	RS485 or RS232 Selection.....	82

10.5.2	RS485 Line Termination.....	83
10.5.3	Connecting to Port 1 and 2.....	83
10.6	Connecting to Port 3 for RS232.....	84
10.7	Diagnostic Information.....	84
10.7.1	Loop Configuration.....	84
10.7.2	Loop Communications.....	85
10.7.3	Loop speed reprogramming.....	85
10.7.4	Checking Host Communications.....	86
10.8	Final Checks.....	86
10.9	Commissioning Aids.....	86
11	MASTER STATION SOFTWARE VERSION.....	89
12	SET UP DATA RECORDS.....	91
12.1	Loop Map.....	92
13	TECHNICAL SPECIFICATIONS.....	95
13.1	Master Station.....	95
13.2	Actuator Field Units.....	95
13.3	GP Field Unit.....	95
13.4	2-Wire Loop.....	96
13.5	Peer Highway Cycle Time.....	97
13.6	External Connections.....	98
13.7	Master Station Dimensions.....	100
13.8	Pushbutton and LED Label Inserts.....	101
13.9	Communication Port Typical Connections.....	102
13.10	Sequencer Information.....	103
13.11	Maintenance.....	104
14	GENERAL SAFETY INFORMATION.....	105

List of Figures

Fig 1:	Front View and with Door Open.....	13
Fig 2:	Outline of Pakscan System.....	16

Fig 3: Loopback system.....19

Fig 4: Pakscan IIS main circuit board.....22

Fig 5: Screens to earth bar.....25

Fig 6: Screens to master station earth.....25

Fig 7: Mounting height.....27

Fig 8: System wiring28

Fig 9: Screen connection.....29

Fig 10: Front panel control keys31

Fig 11: Menu structure.....32

Fig 12: Idealised Loop Waveform, monitored at the master station.....80

Fig 13: Peer to Peer master station communication81

Fig 14: Paktester.....87

Fig 15: Pakreader87

Fig 16: Terminal Connections.....98

Fig 17: Dimension Details.....100

Fig 18: Door Label101

Fig 19: RS232 connections102

Fig 20: RS485 connections102

rotork
Control & Safety

**Declaration of conformity according to article 10 of
directive 89/336/EEC and article 5 of directive
93/68/EEC of the European Community**



Description of apparatus:-

- a) ES series safety shutdown and protection modules
- or b) Orbus, MicroDCS series SCADA and DCS modules
- or c) Pakscan IIE master station modules
- or d) Pakscan IIS master stations
- or e) Pakscan RM or WP series field units codes 2xxx2 or 2xxx3
- or f) Diamond DN series signal conditioning modules

Manufacturer:-

Rotork Control & Safety Ltd
Chaul End Lane
Luton
England, LU4 8EZ

Reference to specifications:-

- BS EN 50081 part 2 1994 EMC generic emission standard
- industrial environment (EN50081-2)
- BS EN 50082 part 2 1995 EMC generic immunity standard
- industrial environment (EN50082-2)
- BS EN 61010-1 general requirements (for LVD)

Limitations and special precautions:-

Conformity is conditional upon installation in racks according to our drawings 5193-021 (for a), 6001-514 (for b), 5206-023 (for c), or 5222-023 (for d), and upon housing in properly-bonded metallic enclosures, upon the adoption of the cable arrangements specified in 8003-014, and upon any other requirements of the specific product documentation.

With reference to EN50082-2, performance criteria 'A' is applied to safety-critical functions and criteria 'C' to all other functions.

Declaration:-

I certify that the apparatus specified above conforms with the protection requirements of Council Directives 89/336/EEC, relating to electromagnetic compatibility, and 93/68/EEC, relating to low voltage, on the approximation of the laws of the Member States.

Signatory:-

Date:- 20-11-00

G Harris, Development & Production Manager responsible for Technical Affairs

9004-111 / 2.0

How to use this Manual

In order to make the best use of the information in the following pages we suggest you use this manual as follows:

- Familiarise yourself with the hardware - Section 2 will show you all the parts.
- Read Sections 2 to 7 before attempting to commission the system.
- Refer to Section 6.1 to check the internal link settings
- Make sure you understand how to connect the system - Section 7 tells you how.
- Find out about the screen displays, there are examples of all screens in section 8
- Set up the Software selected parameters - see Section 9
- Commissioning the system is explained in Section 10.
- Record the information about your system on data sheets like those outlined in Section 12.
- Section 13 has technical information you might need

Software level

This technical manual relates to Pakscan IIS master stations with software version **5222-020 V3.0** or later for the main V25 processor and version **5206-034 V5.2** or later for the loop processor.

(This page is intentionally blank)

1 INTRODUCTION

This manual describes Pakscan IIS equipment and the procedures for setting up and commissioning a Pakscan IIS master station. If the unit is to be stored for a period of time prior to its use, then please refer to Section 3 for information about storage of electronic equipment.

The Pakscan IIS master station hardware is a stand alone unit requiring only the connection of power and suitable field units to operate. This manual describes the Pakscan IIS master station only. Please refer to the documentation relating to the field units for information on that part of the system.

The Pakscan IIS system is compatible with all Pakscan II and IIE field units and setting tools. It also includes the ability to be programmed to operate plant sequences and to interlock the plant output commands. The information relating to the construction and downloading of these programmable functions is contained in the SCT programming manual.

The Pakscan IIS is equipped with three serial communication ports through which the master station can be controlled and operated from another device, or the SCT programme may be downloaded. The communication protocol supported by these ports is Modbus RTU and details of the function codes and data base organisation already established within the master station are contained in the associated protocol documents. All connections to the Pakscan IIS are via screw terminals.

1.1 Related Documents

There are a number of documents for the Pakscan system that relate to the Pakscan IIS master station these include:

General

- | | | |
|-----|---|----------|
| (1) | Pakscan IIS SCT Programming Manual | 6000-100 |
| (2) | Field Test Unit Technical Manual (Paktester) | S178E |
| (3) | Master Station Test Unit Technical Manual (Pakreader) | 5161-021 |
| (4) | Pakscan IIE RS485 Converter Technical Manual | 5218-023 |

Serial Communications

- | | | |
|-----|--|-------|
| (5) | Pakscan Modbus Interface Specification | S171E |
|-----|--|-------|

(This page is intentionally blank)

2 EQUIPMENT DESCRIPTION

The Pakscan IIS master station is a stand-alone unit suitable for mounting on a flat vertical surface. The enclosure is sealed, weatherproof and requires front access to the unit. The door, hinged on the left, provides access to the terminals and circuit board inside. The door is released by turning the two quarter turn fasteners through 90 degrees anti-clockwise. All cable entries to the enclosure are in the bottom.

Internally there is a single circuit board mounted in the enclosure that contains all the field terminals, the system power supply and power terminals, and all the electronic parts. The door carries a second circuit board that has the display module, keypad, function buttons and LED's mounted on it. Both of these internal circuit boards are protected by covers that prevent inadvertent access to the electronic components or high voltage circuits. When these covers are in place the power, input and output terminals remain accessible.

The Pakscan IIS is suitable for an a.c. power supply and there is a single fuse fitted internally. The a.c. power is wired to three terminals (LNE) on the main circuit board.

There are 33 screw terminals provided for the system inputs and outputs. Host communication ports 1 and 2 use terminals 1 to 8 and 9 to 16 respectively and they may be configured by links to be either RS232 or RS485, whilst port 3 is RS232 only and connects to terminals 24 to 26. The remaining terminals are used for the 2 wire loop connections and other system functions.

There are no facilities for including any additional option cards within the Pakscan IIS enclosure. The Pakscan IIS master station does not support dual redundant station configurations.



Fig 1: Front View and with Door Open

(This page is intentionally blank)

3 STORAGE PROCEDURE

On receipt the hardware should be examined for signs of damage and to ensure that the expected equipment is present.

If the unit is to be stored for a period of time then normal conditions for keeping electronic hardware must be provided.

The ambient conditions should remain in the following bands at all times:

Temperature:	10 to 30° C
Humidity:	Not to exceed 80% R.H.

The equipment should not be stacked, though it may be stored in any orientation. The original packing should be retained. **DO NOT LOSE THE MANUALS.**

If it is to be kept for a prolonged period then an electrical exercise test is recommended every 6 months, for 24 hours. The master station internal battery has a shelf life of approximately 3 years.

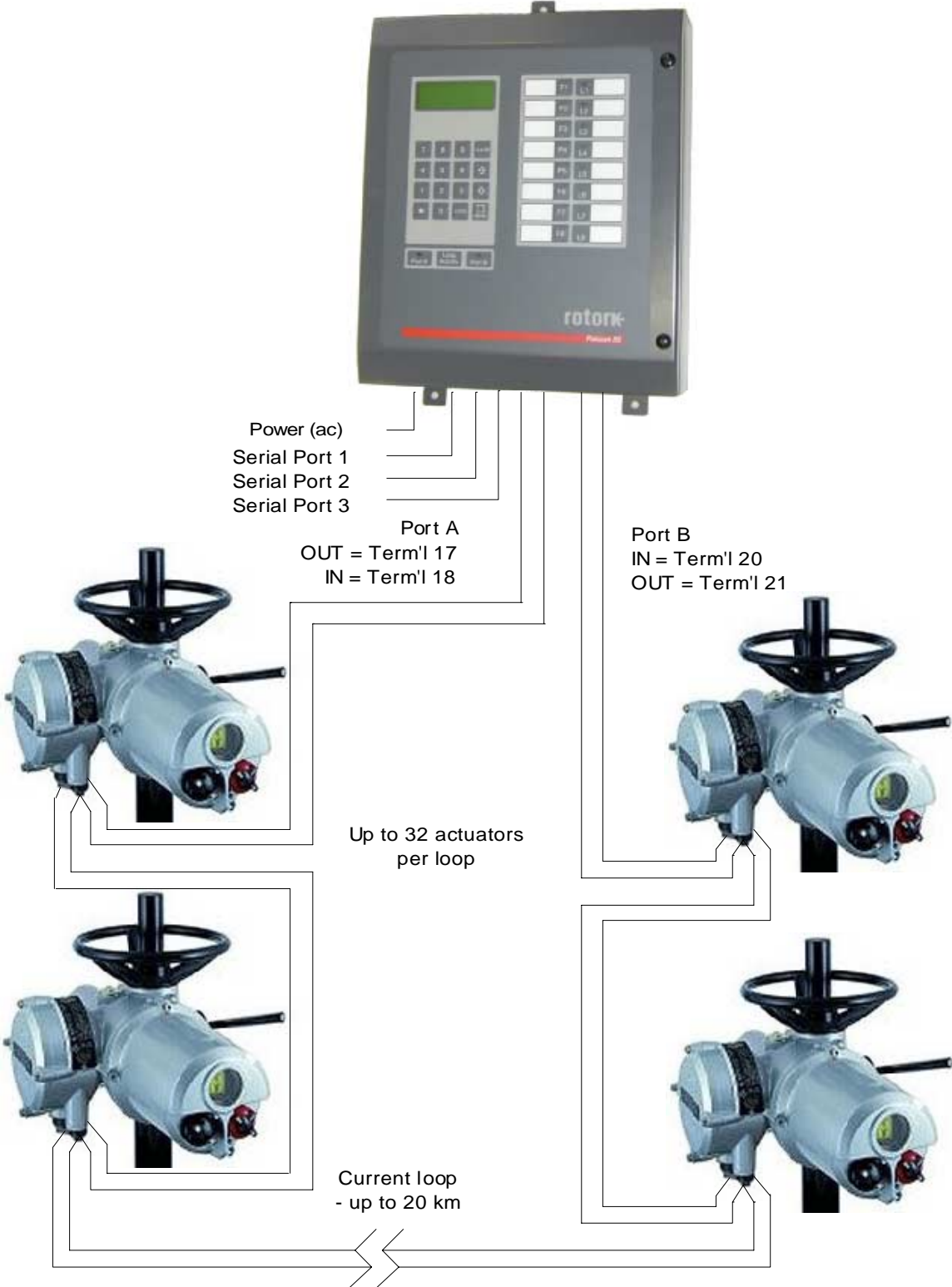

Fig 2: Outline of Pakscan System

4 OVERVIEW OF PAKSCAN

The Pakscan system is a data monitoring and control system which comprises a master station, in this case a Pakscan IIS, servicing a current loop which can have up to 32 field units connected to it. The current loop may be up to 20 kilometres long. Fig 2: shows an outline of the system.

In addition to controlling the loop, the master station also provides the external interface to the system. It supports 3 serial ports for communications to host computers or peer to peer communication, as well as providing a local user interface. When the peer to peer function is required, Port 1 must be used and data may be exchanged between up to 32 Pakscan IIS master stations.

The loop cable is a single twisted pair, with screen is recommended, that forms a complete loop visiting each field unit in turn and starting and finishing at the master station. This cable carries the 20 mA signal and is designed to withstand any single fault (open circuit, short circuit or ground fault) and still maintain communications with all the field units.

4.1 Field Control Units

A range of field control units (FCU's) is available to cater for specific application areas. These may be summarised as follows:

- ❑ Integral type field control units mounted within a Rotork actuator electrical housing.
- ❑ Externally mounted field control unit. Various packages are available, including 'Pakbox', weatherproof box, or rack mounting. The unit may be used for either actuator control applications, or for general purpose applications such as pumps, blenders etc. Its complement of I/O is 8 digital inputs, 4 changeover relay outputs, 2 analogue inputs and 1 analogue output.

4.2 Control and Indication

The field units each report information to the master station which can be viewed on the integral LCD display, or collected from the serial communication port of the master station for use on another display system. The reported data is already organised and requires no configuration by the user; each field unit automatically reports all its available data.

Commands to operate the output devices may be sent over the system, the initiation of the command can either be from the integral keypad (under the correct access code) or from the serial data link. Once again the organisation of these commands is already configured and the user only has to address the correct register to implement the command.

(This page is intentionally blank)

5 FUNCTIONS

5.1 Cable Fault Protection – Loopback System

Communication between the master station and the field control units is via a 2 wire current loop. In normal operation, current flows round the loop on one wire and returns within the master station itself - the second wire is redundant in this case.

Each field control unit has the capability to short the 2 wires together (loopback), and this mechanism is used to divert the current in the event of a loop fault. With field units each side of a loop fault 'in loopback', the system can still communicate with all field units by operating the system as 2 'arms'. If there are 2 loop faults, those field units between the faults will be isolated.

A loop fault may be an open-circuit, a short-circuit, or an earth fault.

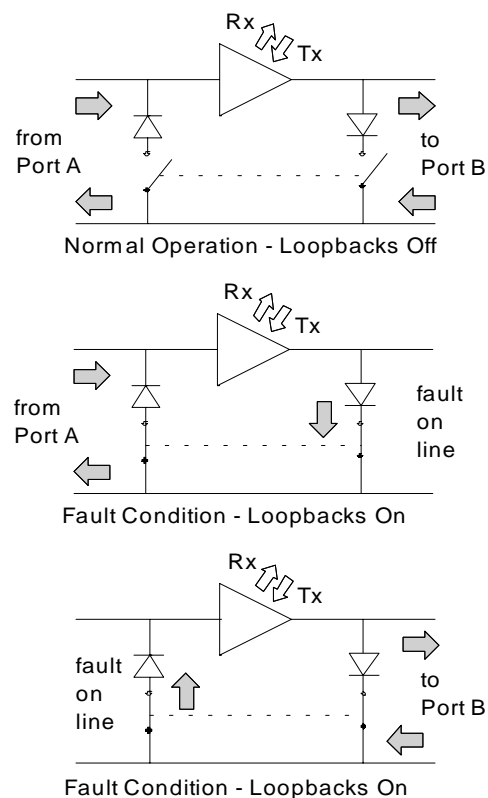

Fig 3: Loopback system

5.2 Current Loop Operations

The Pakscan IIS controls the current loop which communicates with the attached field units. Loop communications divide into two parts; configuration (when the master station decides whether the loop is complete, and if not, where the faults are) and normal operation.

5.2.1 Loop Configuration

The loop configuration phase is entered after power-up, after a loop fault is detected, or after a loop configure command is received.

Configuration consists of the following steps: -

1. Wait for all the field units to go into loopback. The time is dependent on the loop baud rate.
2. Issue a command from Port A to ask a field unit in loopback for its address. This finds the first field unit.
3. Use that address to tell the field unit to remove its loopback.
4. Repeat steps 2 and 3 until no more field units are found.
5. Attempt to send a message right round the loop and receive it back at the sending end. This tests the integrity of the complete loop.
6. If the loop is complete stop here. If the loop has a problem execute steps 7 to 10.
7. Repeat steps 2 to 4 from Port B.
8. Again wait for all field units to go into loopback.
9. Remove loopbacks one field unit at a time from Port A until only the last field unit is left in loopback.
10. Repeat step 9 for Port B.

Loop configuration will identify and mark as out of service any field unit is found which has an address which is zero, an address which is the same as one which has already been found, or which has an address which is too high.

The master station has the facility to double the loop Baud rate. If this facility is enabled, via the Keypad, the master station will issue a broadcast command to all the field units to get them to double the baud rate they are using, once it has detected that the loop is complete.

5.2.2 Normal Operation

In normal operation, the master station polls each field unit for any changed data it has to report. Most of the time, field units have no changes to report, and traffic on the loop is kept to a minimum. Field units are polled in address order. Data, which might be reported, includes changes to digital inputs, alarm changes, or significant changes to an analogue input.

If a field unit which responded on the last scan fails to respond correctly, the master station will retry twice to get a reply. On subsequent scans only a single attempt is made to get a response.

All field units up to the address preset in the master station database are polled. Thus new field units, which are powered-up on a working loop, will be 'found' by the master station provided they are within the selected address range.

Commands to field units (open, close, etc.) are interleaved between polls.

A check is made at the end of each scan to see if a loop fault has occurred. For a complete loop (no loopbacks), a test message is sent round the loop; for a broken loop (loopbacks in use), communications failure to the last field units is taken as an indication of a fault. In the event of a fault being detected, loop re-configuration is initiated.

5.3 Modbus Serial Interfaces

The Pakscan IIS master station may be configured with three Modbus serial interfaces, or two Modbus interfaces and one peer to peer interface. In the former case, the three Modbus interfaces perform similarly.

The master station's use of the Modbus protocol is described in detail in the protocol documents listed in section 1.1 (Related Documents). The master station may operate differing protocols from each of its three ports. The protocols available are indicated on the set up screen display, (see screen displays, section 8).

The three serial ports can both issue commands to field units via the master station, and to the master station itself. Four separate registers of field unit alarms are maintained by the master station; one for each of the three serial ports and one for the front panel display. This ensures that alarms cannot be missed by any of the interfaces. If the host system is reading alarms from the data bases it must consider each one separately and perform the read and accept routines for each link. Accepting an alarm on the serial interface does not accept the alarm on the display, or vice versa.

Note that the multi-drop RS485 peer to peer function is only available on Port 1 and that Port 3 is only able to use RS232 communications.

5.4 Local User Interface (LCD and Keypad)

The Local User Interface allows the master station to be interrogated directly for its own status and diagnostic information, and for field unit status. Various parameters may also be configured from the front panel and commands sent to field units.

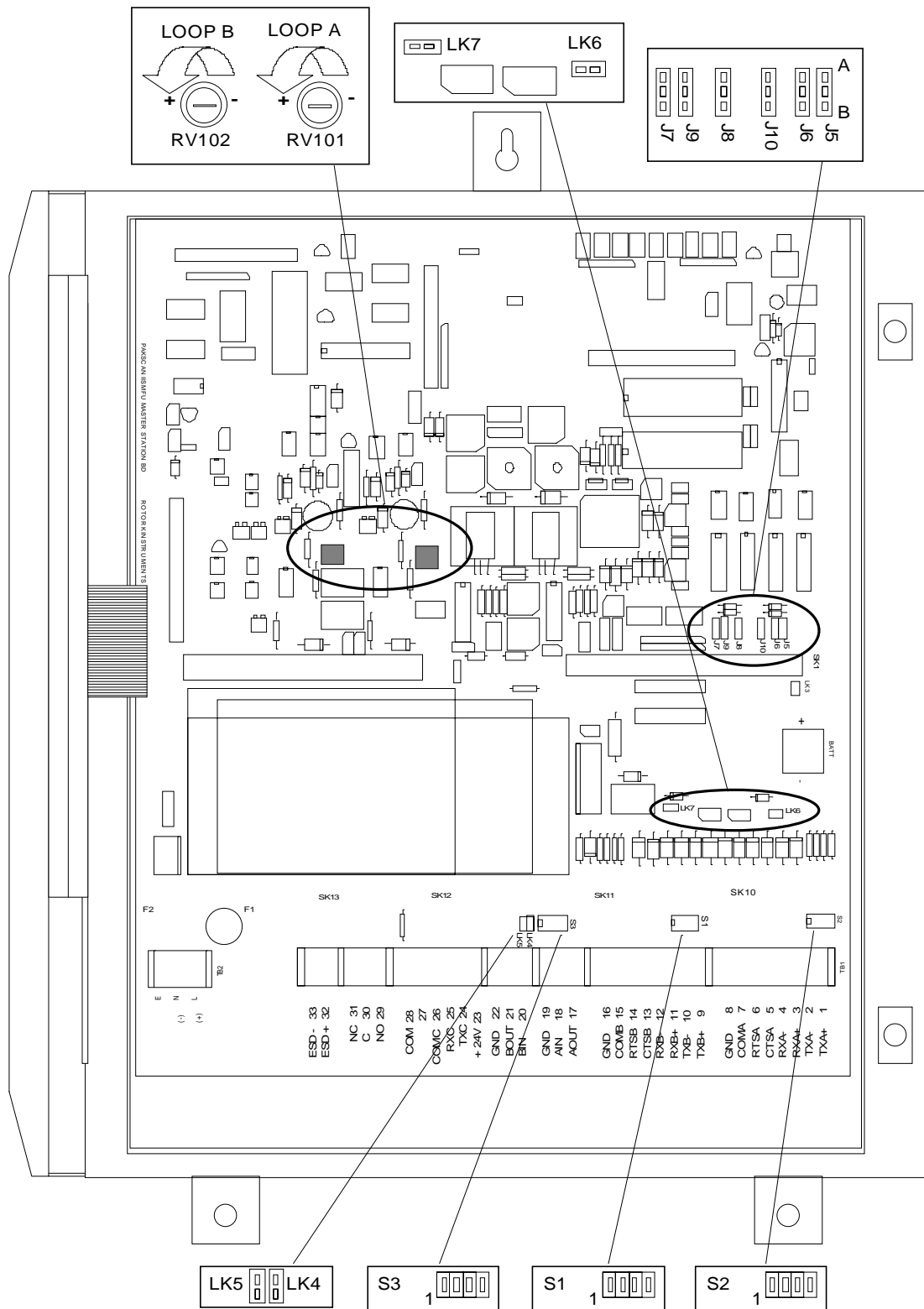

Fig 4: Pakscan IIS main circuit board

6 INITIAL SETTING UP

Before applying any power to the master station check that the internal settings of the jumpers match the system requirements. These jumpers will have been factory set to the default positions, or to user specified positions, prior to dispatch.

In addition to the internal jumpers there may be a need to fit external links to achieve satisfactory operation of the installed unit. These links can be fitted prior to installation.

The main pcb cover carries a label giving details of all the connection jumper settings and also showing how to install the field cabling. There are no jumper settings or links to be made on the display pcb on the door.

6.1 Jumper and Link Settings

The main circuit board contains a number of Jumpers and Links to set the parameters for the performance of the unit. These are factory set and the unit will be fully operational. However there are links which may need to be fitted in order to match each particular application.

The diagram Fig 4: is a view of the main circuit board with the door open and internal cover removed.

The function of the jumpers and links is listed in the table below, please note that some select the type of integrated circuit used, and therefore may vary from one unit to another.

Jumper / Link	Function	Default	Action
J1	Dual Port Memory size select	no	not applicable
J2	EPROM select	B position	set EPROM size
J3	EPROM select	A position	set EPROM size
J4	RAM select	A position	set RAM size
J5	Port 1 mode	A position	select RS232
J6	Port 1 RTS	A position	select RTS
J7	Port 2 CTS	A position	select CTS
J8	Port 2 mode	A position	select RS232
J9	Port 2 RTS	A position	select RTS
J10	Port 1 CTS	A position	select CTS
J11	Memory Capacitor discharge	no	not discharged
J12	Watchdog reset disable	no	enable reset
J13	Plant power monitor	no	check main power supply
J14	Plant power external supply	yes	use main power supply
J15	Flash memory	B position	enable support
LK1	P+Q jumpers (physical address)	no	not applicable
LK2	Not fitted		

(no = not fitted, yes = fitted)

Jumper / Link	Function	Default	Action
LK3	Not used		
LK4	Screen A to earth select	yes	link screen 'A' to earth
LK5	Screen B to earth select	no	screen 'B' not connected
LK6	Port 1 mode select	yes	select RS232
LK7	Port 2 mode select	yes	select RS232

J2, J3 - EPROM Memory Size Select

The usual size is 27c2001 though other devices may be fitted. These settings do not require adjustment after leaving the factory.

EPROM Type	J2	J3
27c512	no	B position
27c1001	B position	no
27c2001	B position	A position
27c4001	A position	A position

J4 - RAM Select

The standard unit has a 4 Meg RAM chip fitted.

RAM Type	J4
1 Meg	B position
4 Meg	A position

J5, J6 and J10, LK6 - Comms Port 1

These select the mode for Port 1 communications, either RS232 or RS485. In addition if, when in RS232 mode, there is a need for modem control lines the signals to these can be enabled or disabled. The modem control line links (J6 and J10) should not be fitted if the port is in RS485 mode. The default setting is for the port to be set for RS232 with modem control enabled.

Port 1	LK6	J5	J6 (RTS)	J10 (CTS)
RS232	yes	A	A	A
RS485	no	B	no	no

J7, J8 and J9, LK7 - Comms Port 2

These select the mode for Port 2 communications, either RS232 or RS485. In addition if, when in RS232 mode, there is a need for modem control lines the signals to these can be enabled or disabled. The modem control line links (J7 and J9) should not be fitted if the port is in RS485 mode. The default setting is for the port to be set for RS232 with modem control enabled.

Port 2	LK7	J8	J9 (RTS)	J7 (CTS)
RS232	yes	A	A	A
RS485	no	B	no	no

J11 - Memory backup capacitor discharge

This link provides the facility to completely discharge the RAM power supply capacitor. The RAM data is supported by a large capacitor that is effective for several minutes in keeping the chip data valid whilst the main battery is changed. If the contents of the RAM are to be eliminated and the system returned to its default values then the battery can be removed and this link fitted to discharge the power source. Discharging completely will take several hours.

The link is normally not fitted. Great care must be exercised if the link is to be fitted.

J12 - Disable automatic watchdog reset

When fitted this link disables the watchdog circuit from resetting the processor. It is not normally fitted, as in most cases it is desirable to restart the processor on a watchdog failure.

J13 - Plant power monitor disable

This link should never be fitted to the master station. It determines the method of power monitoring of the system.

J14 - Plant power external supply option

This link must always be fitted as the main circuits always use the primary on board power module fitted just above the terminals.

J15 - Flash memory

Flash memory is not normally used in this unit. This link, in conjunction with J2 can be used to provide support for flash memory if it is fitted to the board.

Memory	J2	J15
Flash	C	B
Standard	see J2 settings	no

LK1, LK2 and LK3

These links are not used in the Pakscan IIS system and should not be fitted.

LK4 and LK5 - Screen to earth connections

In order to comply with directive 89/336/EEC of the European Community it is necessary to use a screened cable for the 2 wire loop and to connect the master station to earth through a suitable bonding conductor. The cable must have BOTH the screen connections terminated at the master station, to terminals 19 and 22 as indicated. These connections are then decoupled to earth through suitable capacitors fitted to the Pakscan IIS itself.

Signal Earthing	LK4	LK5
Using IIS	yes	no
External ground	no	no

It is also desirable to bond the screen to a suitable ground to reduce the system susceptibility to noise. This bonding can be achieved either by using the Pakscan IIS ground connection and fitting LK4, or by connecting the screen to a suitable external earth. Even if an external earth connection is used it is still required to connect the screen to the Pakscan IIS terminals in order that the cables from the unit are correctly decoupled.

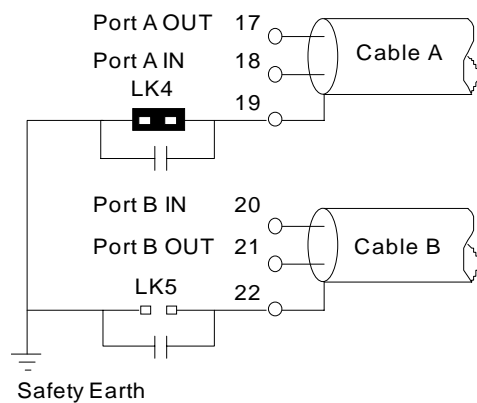

Fig 5: Screens to earth bar

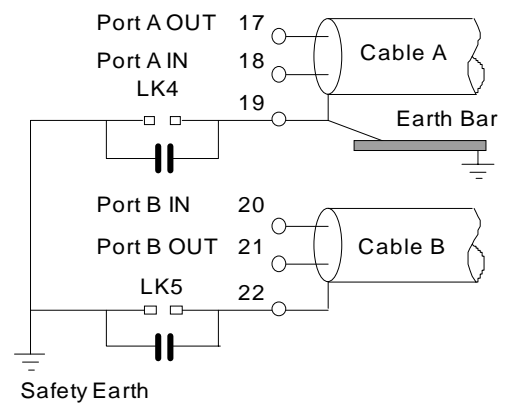

Fig 6: Screens to master station earth

6.2 Using S1, S2 and S3 to set Port 1 and 2 RS485 line options

In order to simplify the setting up of the RS485 highway to be either 2 or 4 wire and to provide line termination 3 off 4-way DIP switches are provided inside the Pakscan IIS. S1 is used to select 2 or 4 wire operation for both the comms ports and S2 and S3 connect the termination resistors.

Note: For Port 1 and 2 in RS232 mode all these switches must be set 'Open'. Port 3 is always RS232

S1 - Select 2 or 4 wire RS485

Port 1	S1-1	S1-2	S1-3	S1-4
RS232	Open	Open	X	X
RS485 - 4 wire	Open	Open	X	X
RS485 - 2 wire	Shut	Shut	X	X

Port 2	S1-1	S1-2	S1-3	S1-4
RS232	X	X	Open	Open
RS485 - 4 wire	X	X	Open	Open
RS485 - 2 wire	X	X	Shut	Shut

S2 - Select Line Termination for Port 1

Port 1	S2-1	S2-2	S2-3	S2-4
RS232	Open	Open	Open	Open
Terminate RS485 - 4 wire	Shut	Shut	Open	Open
Terminate RS485 - 2 wire	Shut	Shut	Shut	Shut

S3 - Select Line Termination for Port 2

Port 2	S3-1	S3-2	S3-3	S3-4
RS232	X	X	Open	Open
Terminate RS485 - 4 wire	X	X	Open	Open
Terminate RS485 - 2 wire	X	X	Shut	Shut

6.3 External Links - ESD (Emergency Shut-down)

Terminal 32 & 33 - ESD (Emergency Shutdown)

The Pakscan IIS may be configured for a global command to 'ESD' all the connected devices. One source of the ESD command is connected as an input to these terminals.

When configured to do so, the system will issue 3 consecutive ESD commands to the Loop whenever these two terminals are unconnected. A remote ESD contact, process normal closed, may be connected. If the contact opens, then an ESD is issued.

If the ESD function via these terminals is not required then it may be removed from the configuration or, if it remains an enabled option, a link **MUST** be fitted between these terminals.

6.4 Display Screen Contrast

On the rear of the door is a multi-turn potentiometer, which is used to adjust the contrast of the LCD display. Access to this potentiometer is provided through a small hole in the cover, adjusting clockwise increases the contrast.

7 INSTALLATION AND CONNECTION

Once the links and jumpers are set the master station is ready for installation and connecting to the 2 wire loop.

7.1 Mounting

The Pakscan IIS master station should be mounted on a flat vertical surface and in a suitable environment. The height of the front should be between 1.0 m and 1.7 m above the floor so that the screen may be viewed and the keys accessed. There should be no equipment in front of the master station and sufficient space should be left below the unit to provide for the connecting cables. The door hinges on the left and sufficient space should be provided to allow clear access when the door is open.

All connections are to the front terminals of the master station.

7.2 Power

The unit will operate on an a.c. supply between 90 and 264 volts, 43 to 440 Hz, single phase.

In order to comply with the EC Directives and plant safety requirements it is essential that an Earth connection is made to the master station via the terminal and/or the safety earth stud.

7.3 Field Wiring

The field wiring includes the loop wires to the field units. The loop cable should have an overall electrical screen. Particular attention should be paid to the connection of the screen on this cable.

The wiring should be in accordance with the diagram Fig 8:

The system is a current loop, and Port A Out (terminal 17) connects via all the field units to Port B In (terminal 20), whilst Port B Out (terminal 21) connects similarly to Port A In (terminal 18). If a coloured pair, red and blue, is used this results in say the red wires being in terminals 17 and 20, with the blue wires in 18 and 21. The order is red, blue, red, and blue.

7.3.1 Screen Connections

In all cases you must ensure that a safety earth is connected to the master station.

The screen terminals, 19 and 22, are both connected internally to the enclosure earth via a capacitor. **Both the screens must be connected to the terminals provided** so as to ensure the product meets the European Directive on EMC.

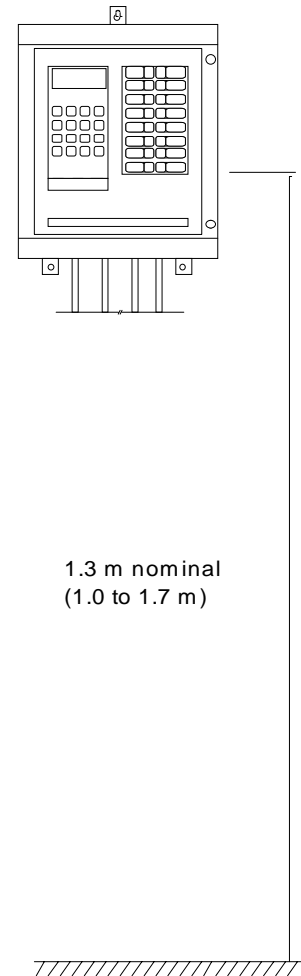

Fig 7: Mounting height

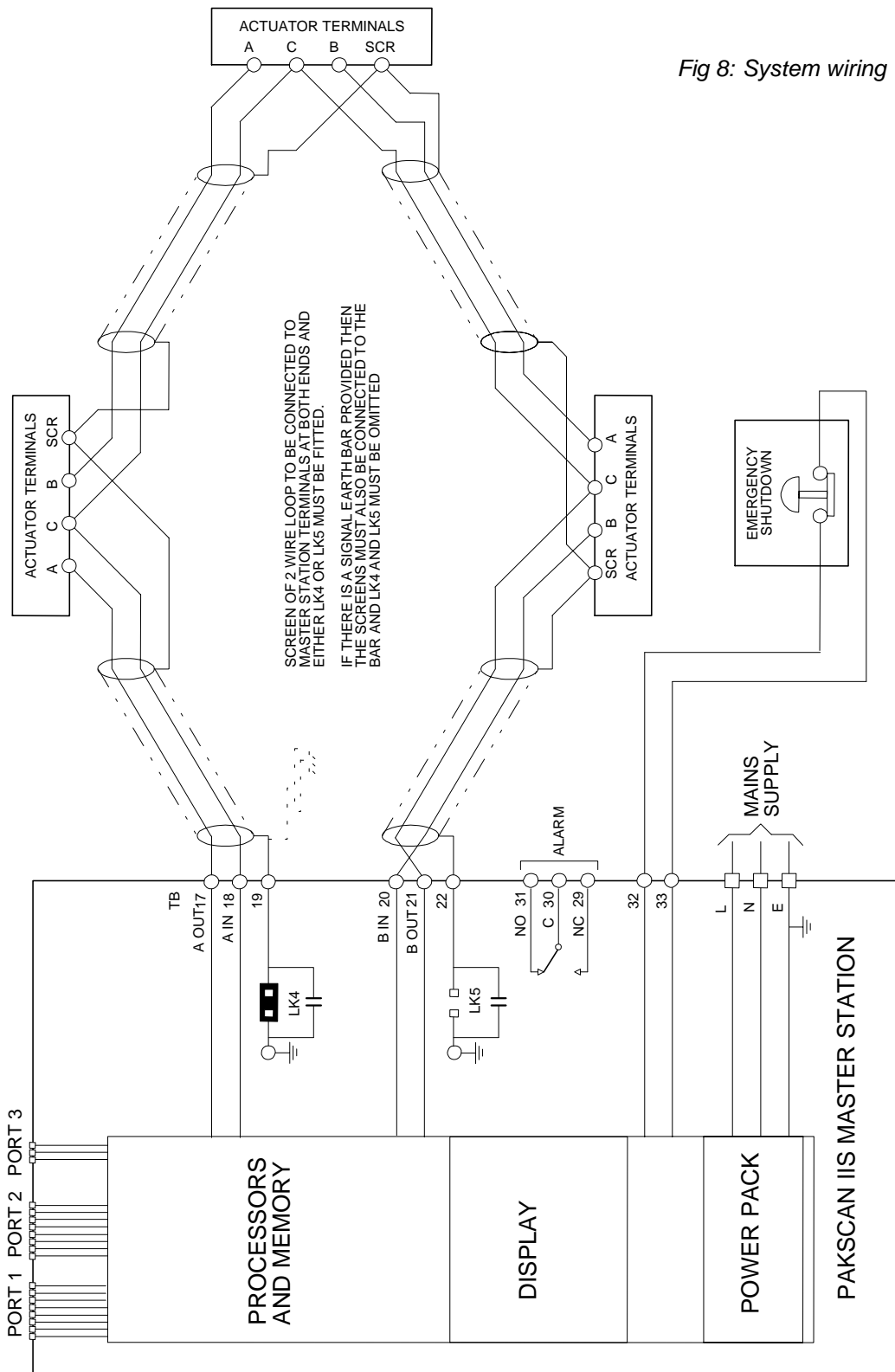
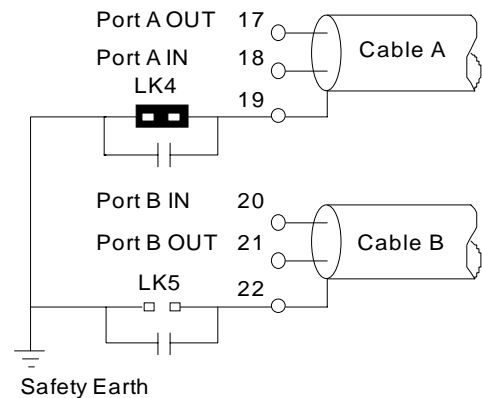

Fig 8: System wiring

If there is no signal earth bar - one of the two links LK4 or LK5 should be fitted. Connect the screen to the master station on both ends of the cable and fit either LK4 or LK5.



If there is a signal earth bar - one of the screens may be connected to the bar in addition to them both connecting to the master station, in this configuration both LK4 and LK5 should be removed.

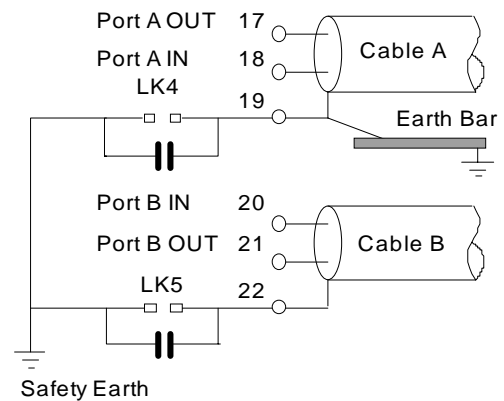

Fig 9: Screen connection

7.4 Loop Checks

Once the loop is fully wired there are a number of checks that should be made before power is applied to any of the connected field units, actuators, or the master station. These simple tests will always help in the start up of the system.

7.4.1 Loop Continuity.

With all the field units connected, but none of them powered up, check the continuity of the 2 cores of the cable using a simple Ohmmeter. (The most common errors in installing the system occur on the field wiring.) To do this, disconnect all the loop wires and the screen from the master station.

Measure, and note down, the resistance of each core. They should be within 20% of each other with the A to B wire greater than the C wire. Check the resistance between the cores, this should be a high resistance as they are not connected together. (Note that if a field unit has power to it, then the internal circuitry will connect the two cores together.)

Join the 2 wires that will be connected to Port B together and measure the total resistance of the whole loop cable - note this down, as you will need it for reference later.

7.4.2 Screen Continuity

With the Port B cables still connected together make sure that the screen is isolated from the loop cores themselves, there should be a high resistance between screen and cores.

Now check that the screen is isolated from earth by measuring the resistance between the screen and your screen earth point.

7.4.3 Cable Capacitance

The capacitance between the cores, and to the screen, is critical to the system performance. Too high a capacitance for the selected loop baud rate will result in poor communications, or even communication failure.

Disconnect the join between the 2 cores that connect to Port B so that the cores and screen are now all separated.

With your digital meter set to Capacitance, measure the core to core capacitance, and note it down. Also measure the core to screen capacitance for both cores, it will probably be slightly higher than the core to core capacitance. If any problems are encountered during these tests rectify them before proceeding.

Once these checks have been made the 2 wire loop is ready to be commissioned. Use the values measured to select a suitable baud rate for the system (use the technical data in section 13.4 to determine the baud rate). Section 10 deals with setting up the field units and the system as a whole. It is also necessary to set up various parameters in the master station itself. Once the loop and field units have been set up using a Paktester, the power may now be applied to the master station taking care to ensure that the plant is in a safe state and all the actuators are in local control.

Results of Cable Checks	
1.	Resistance of core 1 =
2.	Resistance of core 2 =
3.	Resistance between core 1 and core 2 = (must be more than 100kΩ)
4.	Total resistance of both cores = (must be less than 500Ω) (should be sum of (1) and (2))
5.	Cable to screen resistance = (should be a high value)
6.	Screen to earth resistance = (should be high)
7.	Capacitance core to core =
8.	Capacitance core 1 to screen =
9.	Capacitance core 2 to screen = (should be the same as (8))

8 LCD AND KEYPAD

The front of the master station has the user interface LCD and Keypad, plus the user defined function keys and LED's. This section of the manual deals with the user interface, information on the user defined displays can be found in the Pakscan IIS SCT Programming manual.

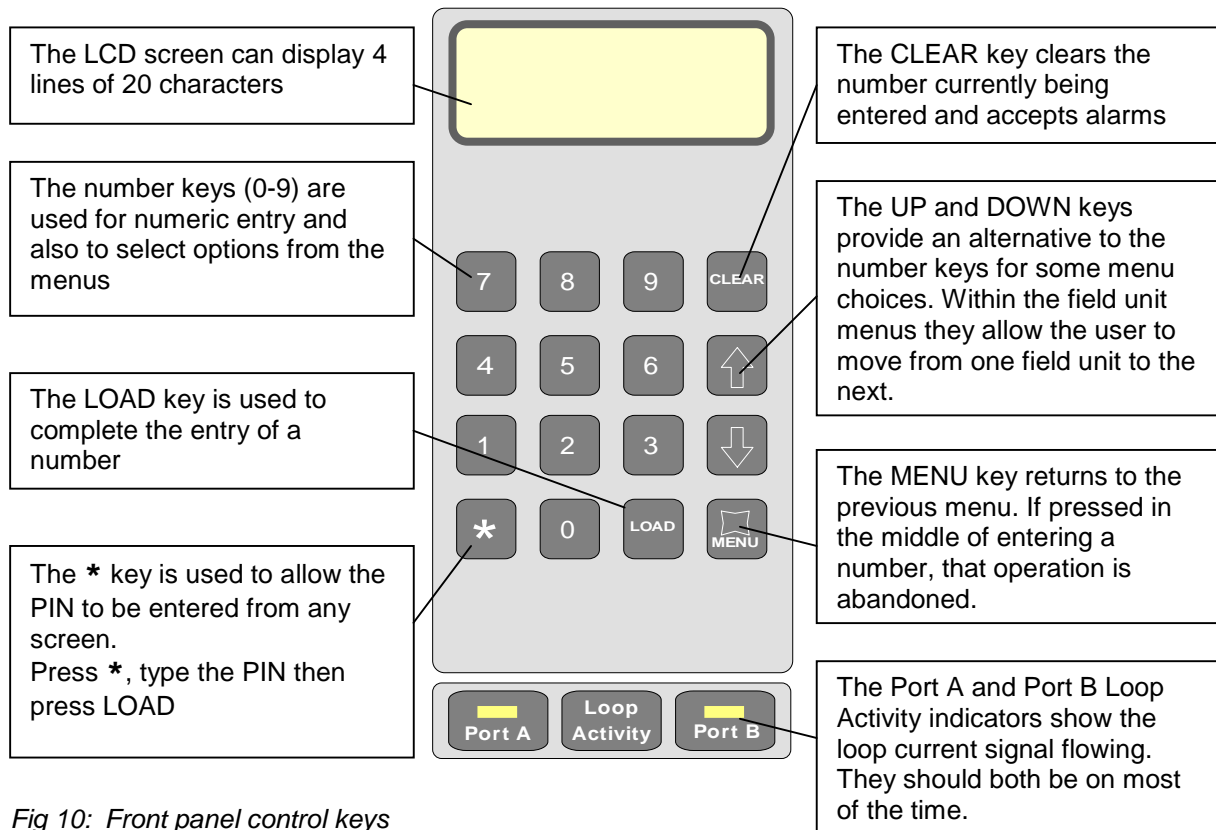

Fig 10: Front panel control keys

8.1 Keypad Security

The Pakscan IIS master station can be protected against unauthorised changes by a password, or 'PIN', mechanism.

Note: If a PIN has been programmed, it must be entered before particular functions can be accessed. These functions then remain accessible whilst keys are being pressed and for 30 seconds after the last key press.

Note: It is not possible to recover a 'lost' PIN. There is no default PIN. Once lost the only way to recover the system is to remove the battery which results in total data loss. In some cases, returning the unit to Rotork may allow a Pin to be recovered.

8.1.1 Using a PIN

The PIN can be entered from any screen by pressing the star key (*). You are then prompted to type in the PIN, followed by 'LOAD', before being returned to the previous screen. The numbers you enter are not displayed as you type them in.

8.2 Menu Structure

Each page offers the user options to enter commands or move to a different page. The structure of these menus is outlined in the diagram and detailed in the following sections. The menu pages that appear depend on the connected field units and options chosen.

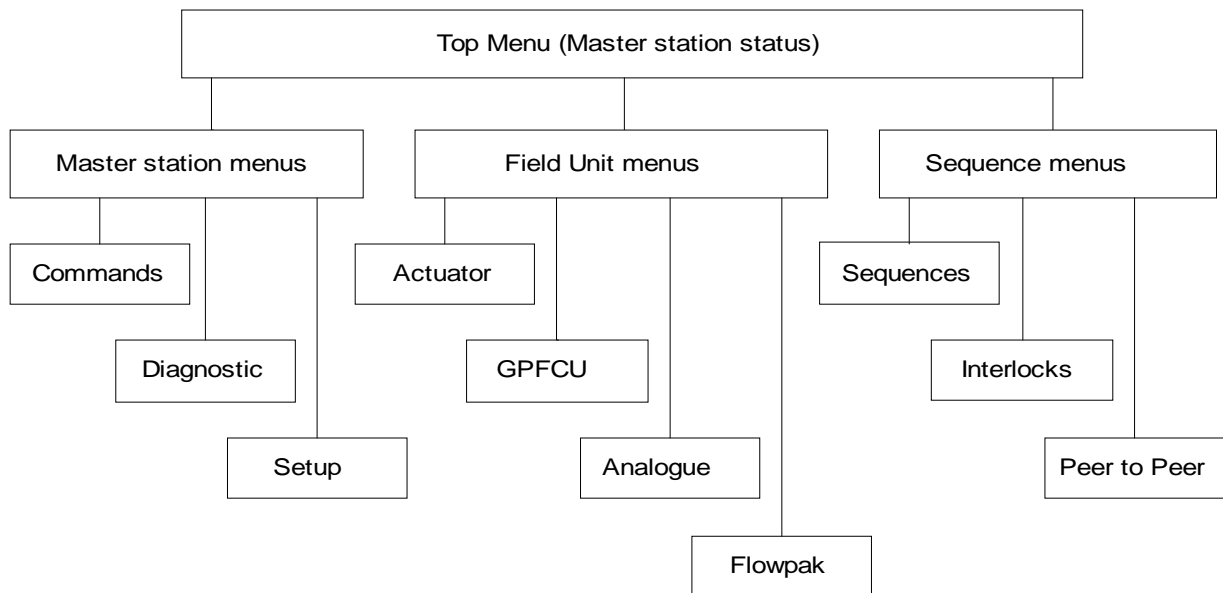

Fig 11: Menu structure

Menu pages are reached by using the number keys on the control pad. Commands and settings of the system require that the correct security level is chosen and, when selected, the PIN is entered. All commands must be verified by the LOAD key and may be cancelled by the CLEAR key. The MENU key always returns to a higher level in the structure.

Top Menu – Master Station Status

1. Master Station Status, Alarms and Tag
 1. Reset Loop (reconfigure the 2 wire loop)
 2. Start Configuration Mode (enable the use of Pakloader)
 4. Diagnostics (enter Diagnostic mode) Software Version, Port status
 1. Port 1 Port Activity
 1. Peer Map Peer to Peer activity
 1. Change peer displayed
 2. Port 2 Port Activity
 3. Port 3 Port Activity
 4. Loop Loop status
 1. Loop Map
 2. Loop Test
 3. Address fault prompt
 5. Setup (enter Setup mode)
 1. Ports
 - 1, 2, or 3 Select Port 1, 2 or 3
 1. Set use
 2. Set protocol
 3. Set speed
 4. Set Parity
 6. Set Alarm Options
 1. Separate or Linked alarms for ports
 3. Loop Shows current loop status and settings
 1. Set speed (shows current speed)
 2. Set new FCU speed (for global change)
 3. Set Number of FCU
 4. Set Doubling status
 5. More options
 1. Retain last data on comms fail
 2. IQ DV convert (0% to 'Close')
 4. Address Shows current address settings
 1. Set master station address
 2. Set sequence download address
 3. Set peer number
 5. Tags Sets up all tags
 1. Set master station tag
 2. Select FCU number (to change tag)
 3. Set FCU tag
 6. Time Shows current date and time setting
 1. Set Date
 2. Set Time
 7. ESD Shows current ESD option settings
 1. Enable/Disable Serial Comms ESD
 2. Enable/Disable Keypad ESD
 3. Enable/Disable hard wired ESD input
 8. Security Shows current security level
 1. Set PIN in or out of use
 2. Set PIN
 3. Set access level
 9. ESD (initiate an ESD)

Top Menu – Master Station Status

2. Field Units Shows status of selected field unit

For non IQ Actuators -

- 1. Open command
- 2. Close command
- 3. Stop command
- 4. Set Desired Value output
- 5. Block and Parameter screen
- 9. Alarms text
 - 1. Next alarm (if there is one)

For General Purpose FCU

- 1. Show relay output status
 - 1. Control relay 1
 - 2. Control relay 2
 - 3. Control relay 3
 - 4. Control relay 4
 - 5. Set analogue output
 - 6. Block and Parameter screen
- 9. Alarms text
 - 1. Next alarm (if there is one)

For IQ Analogue field unit

- 1. Go to Block and Parameter screen
- 9. Alarms text
 - 1. Next alarm (if there is one)

For IQ Actuators

- 1. Open command
- 2. Close command
- 3. Stop command
- 4. Set Desired Value output
- 5. IQ secondary status
 - 1. IQ Opening Torque display
 - 1. IQ Closing Torque display
 - 1. IQ Opening Torque display
 - 2. Reload closing torque
 - 3. Block and Parameter screen
 - 2. Reload opening torque
 - 3. Block and Parameter screen
- 9. Alarms text
 - 1. Next alarm (if there is one)

For devices not communicating

- 5. Block and Parameter screen

- 1. FCU number
- 2. Block select
- 3. Parameter select

Top Menu – Master Station Status

- 3. Sequence and Interlock menus
 - 1. Sequence
 - 1. Select sequence number
 - 2. Set sequence mode
 - 2. Sequence Data
 - 1. Select General Register
 - 2. Select Sequence Flag
 - 3. Select Modbus register
 - 4. Change General Register contents
 - 5. Change Flag state
 - 3. Interlock Data
 - 1. Interlock status
 - 4. Peer Data
 - 1. Peer number
 - 2. Data item
- 9. Alarm Data (full text alarm message – only visible if an alarm is present)

8.3 Master Station Status

Master tag	Master	MSTAG001
Status	Status=LB OFF	ESD
Alarms	9>Alarms=P	
Options	1>M/S	2>FCU 3>More

This is the first master station screen that is displayed at power-up

The Master Tag is an identity tag that can be configured by the user.

The Status line indicates the loopback status and the ESD input state. The loopback state is displayed as:

- LB OFF** - loopbacks are all off
- LB ON** - loopbacks are in use, i.e. there is a loop fault
- LB busy** - this message appears during loop re-configuration and is one of the following;
 1. LBbusy: Wait for LB 1 (first wait for loopbacks to come on)
 2. LBbusy: Find FCU's on A (finding FCU's on port A)
 3. LBbusy: Test Loop (testing for complete loop)
 4. LBbusy: Find FCU's on B (finding FCU's on port B)
 5. LBbusy: Wait for LB 2 (second wait for loopbacks to come on)
 6. LBbusy: LBs off on A (removing loopbacks from port A)
 7. LBbusy: LBs off on B (removing loopbacks from port B)

(The normal sequence for a fault free loop would be 1, 2 and 3. A sequence for a break in the loop anywhere except at port A or port B, would be 1 to 7. Some of the phases may be very quick, particularly at higher baud rates, and so may not be displayed as the LCD update rate is about twice a second.)

- ESD** - master station in ESD mode, e.g. ESD link broken

The Alarms line shows master station alarms by means of code letters:

- | | |
|--|-------------------------------------|
| F - Memory failure | B - Low battery |
| P - Power on reset | I - Interlock failure |
| auto LB - Automatic loopback occurred | A - Field unit address fault |

□ Commands available:

- CLEAR** - Accept alarms
- 1** - Go to master station menu
- 2** - Go to field unit status page
- 3** - Go to sequences menu
- 9** - Go to alarm detail page (displays full text of system alarms present)

8.3.1 Master Station Commands

```

1>Reset Loop    9>ESD
2>Start Config Mode
4>Diagnostic 5>Setup

```

This screen provides commands and options for the master station itself.

Config Mode forces the selected serial port to a fixed setup so that Pakloader utility can communicate via that port. The RS232/RS485 settings must be made independently. (Pakloader is Rotork supplied utility used to read and write setup and tag data with a PC.)

□ Commands available:

- 1** - Command to re-configure loop. This should be used after a loop fault has been corrected
- 2** - Start or stop Configuration Mode. A port selection screen appears to set the comms port to use with the Pakloader utility.
- 4** - Go to diagnostic menu
- 5** - Go to setup menu
- 9** - Send ESD command to all field units. This option is only displayed if the Keypad ESD has been enabled.
- MENU** - Return to previous menu

After pressing either of the command keys 1 or 9, a confirmation message screen appears asking whether you wish to send the command (e.g. after pressing 1, the Reset Loop key, the following will appear)

```

Reset Loop Command
LOAD to confirm
CLEAR to cancel

```

- LOAD** - Confirms the command previously selected and executes it.
- CLEAR** - Cancels the command previously selected.

8.4 Configuration Mode Screen

```
Select Port for
Upload and Download:
1>Port 1      2>Port 2
3>Port 3
```

This mode forces the selected port to adopt speed, protocol and address parameters that match the settings needed for the Pakloader utility. Pakloader runs on a PC and allows the master station settings to be modified using a PC screen and keyboard. In addition Pakloader will record all the settings present and those of the attached field units. Tags for all devices can be set with the utility.

Select the port to use bearing in mind that the PC probably requires RS232 communications. The hardware settings of the master station must still be set to match the PC.

Commands available:

- 1** - Selects Port 1
- 2** - Selects Port 2
- 3** - Selects Port 3
- MENU** - Return to previous menu

Once selected the screen changes to that below (shown with Port 1 selected).

```
Select Port for
Upload and Download:
Port 1 Config Mode
9600, odd Par, Addr1
```

When Configuration Mode has been finished with select Menu to return to the main menu.

Commands available:

- MENU** - Return to previous menu

8.5 Diagnostic Menus

8.5.1 Top Diagnostic Display

Software Version	S/W:1210 V3. 0/V5. 2
Port 1 Activity	1>P1 Rx Tx
Port 2 Activity	2>P2 Rx Tx
Port 3 Activity	3>P3 Rx Tx 4>Loop

Loop diagnostics

The top line shows the code for the software type fitted and its version numbers:

1210	-	Peer to Peer version, Pakscan IIS, 32 channel, single master station
V3.0	-	V25 processor software release 3.0
V5.2	-	Loop driver processor software release 5.2

The port activity flags flash to indicate when a message is received (Rx), or when a reply is transmitted (Tx).

□ Commands available:

- | | | |
|-------------|---|------------------------------|
| 1 | - | Go to Port 1 diagnostic page |
| 2 | - | Go to Port 2 diagnostic page |
| 3 | - | Go to Port 3 diagnostic page |
| 4 | - | Go to Loop diagnostic page |
| MENU | - | Return to previous menu |

8.5.2 Modbus Port Diagnostic Displays

Port number	1	msg	err	xcpt	crc
Message counts	123		0	0	0
	Mod	func	addr	data	
Last message details	1	2	1920	48	

These screens give detailed diagnostic information for the serial links. The top half displays counts of various message types:

- msg** - count of valid messages received
- err** - count of errors, e.g. overrun errors, parity errors, Baud rate errors
- xcpt** - count of Modbus exception responses generated
- crc** - count of messages received with incorrect CRC's

The bottom half shows details of the last message received, (the address and data in decimal format):

- Mod** - the Modbus address of the last request
- func** - the Modbus function code of the last request
- addr** - the discrete bit or register number in the last request
- data** - the data field of the last request, typically the number of points or registers

Some familiarity with the protocol is needed to make use of this display. Its purpose is help in commissioning a serial communications link to a Host computer by getting the master station to show what it thought it received. If you then refer to the protocol specification you can check whether those messages are correct. The display is normally 'frozen' and is only updated when a key is pressed (any key except the Menu key). This gives time to take note of the numbers. Most Host systems are set up to send out a short sequence of requests for data, and by pressing a key a few times you should be able to capture all the messages. The "Clear" key resets the counters on the top half of the screen.

□ **Commands available:**

- CLEAR** - Zeros the message and error counts
- LOAD** - Or any other key except Clear or Menu updates display with the last message
- MENU** - Return to previous menu

8.5.3 Peer to Peer port diagnostic display

Options	Peer Number = 1	This peer node number
	Peer Master = 2	Current highway master
	Current Scan = 15	Current node being polled
	1>Peer Map	

If Port 1 is set for Peer to Peer use then the diagnostic display will be changed from that shown in section 8.5.2 to the one shown above. The screen shows the number of this peer (line 1), the peer number of the current master (line 2) and the current peer node being scanned (line 3). The 'Current Scan' figure will be a rapidly changing number.

□ Commands available:

1	-	Go to peer map screen
MENU	-	Return to previous menu

8.5.3.1 Peer Map Display

Present/absent indication	1>Peer Number = 1	Peer number
	Present	
Good reply count	Good	Bad/Timeouts
	2345	5

This screen shows whether specific peers are present or absent, and gives statistics about communication from that peer. The Bad/Timeouts message count is only shown on the highway master, as only the highway master can accurately track these failures.

□ Commands available:

1	-	Enter the number of the peer to view
MENU	-	Return to previous menu

8.5.4 Loop Diagnostic Display

	Loop: Fault Found Loop open circuit Loopbacks at 4 5 1>Map 2>Test 7 x2	Reason for last loop configuration
		Fault Found
FCU map/Test/Address fault		Address of fault details
		Loop and doubling status

This screen provides information to aid in commissioning and fault finding on the current loop. Additional screens below this one also contain useful data on the loop status and connected field units.

The Reason message shows the reason why the loop was last re-configured. The message will be one of the following:

- | | |
|--------------------------|---|
| Power on Reset | - loop configured because the master station powered up |
| Fault Found | - fault detected on the loop whilst it was running without loopbacks present |
| Fault Found A | - fault detected on the A side of broken loop whilst running with loopbacks on |
| Fault Found B | - fault detected on the B side of broken loop whilst running with loopbacks on |
| Reset Command | - loop Reconfigure command entered from keypad or serial port |
| Return wire fault | - fault detected in the return current path whilst the loop was running at double speed |
| Doubling failed | - fault detected after loop assumed double speed. |

If a fault occurs, the Fault Found message will be one of the following:

- | | |
|----------------------------|---|
| Zero Address | - a field unit has been found with an address of zero |
| Address too High xx | - a field unit has been found with an address higher than that setup within the master station, xx is the address |
| Same Address xx | - two field units found with the same address, xx is the address |
| Loop Open Circuit | - an open circuit fault found on the loop |
| Loop Short Circuit | - a short circuit fault found on the loop |

Note: In the case of address faults, the master station will continue to operate the loop, missing out the faulty field units. The fault details can be found with command 3'.

If a fault occurs the message on the third line will be:

- | | |
|---------------------------|---|
| Position xx | - xx is the position from A of zero address or address too high |
| Positions xx yy | - xx and yy are the positions from A of the duplicate addresses |
| Loopbacks at xx yy | - cable fault lies between xx and yy |

If there are no loop faults then lines 2 and 3 will be blank.

The right hand side of the fourth line contains a number that indicates the field unit that is currently passing data to the master station (0 or 255 may be shown when no data is being passed), and the message 'x2' indicates when the loop is running at double speed.

□ **Commands available:**

- 1** - Go to FCU map screen
- 2** - Loop speed test (only possible if loop is complete)
- 3** - Field Unit address fault details (only available if an address fault is present)
- MENU** - Return to previous menu

8.5.5 FCU Map and Failure Counts

Physical position	Loop Position = 22	
Address	FCU Address = 17	
Attached port	Port=A Fails = 5	Comms fail count
Field unit type	Type=Act S/W = 2.7	Software version

The screen displays information about field units found on the loop during loop configuration.

The top line shows the physical position on the loop, the second line the address of the field unit found at that position, and the third line the master station port it is attached to. For a complete loop with no loopbacks, all the field units are attached to port A.

The third line also shows a count of communication errors with the field unit whose address is displayed above. The count has a range of 0 to 255, after which it rolls around to zero. The counter increments for every communication error though the system will only announce a 'Comms failure' when 3 successive tries have failed to locate the field unit. This counter therefore reflects the communications condition and can be used as an indicator of the condition of the field unit before it actually may fail completely.



The bottom line shows the type of field unit and the software version of the EPROM. "Type" can be displayed as:

Act	- Non - IQ Actuator
IQ	- IQ Actuator
GP	- General Purpose Field Unit
IQA	- IQ Analogue
PPk	- Flowpak actuator

Information for this screen is available approximately 30 seconds after loop configuration is complete and is upgraded approximately once a minute after that.

The example screen above shows that at loop position 22 there is field unit address 17, and it is attached to port A, that it is an actuator field unit with software version 2.7 and that 5 communications failures have been recorded for it since the system was last reset.

Commands available:

-  - Move to the next field unit
-  - Move back to previous field unit
-  - Return to previous menu

8.5.6 Loop Speed Test

Speed selection	1>Loop Speed = 1200
Perform test	2>Test
Test result	Result 100%

This screen allows the user to cause test messages to be sent around the loop at a defined baud rate. After each test the loop returns to normal speed so that the interruption to FCU communications is minimal. (The loop speed test should be done at speeds higher than the loop is currently running at). The result of the test is displayed as a percentage success rate so that the user may have a degree of confidence in the performance with the loop speed chosen.

□ Commands available

- 1** - Select the test speed, pressing '1' will scroll through the speed options
- 2** - Perform test. This causes a test message to be sent around the loop 10 times
- MENU** - Return to previous menu

The loop speed options are 300, 450, 600, 900, 1200, 1800, 2400, 3600, 4800, and 7200. Some of these speeds cannot be selected for normal use, however they do provide information about the performance margin available.

8.5.7 FCU Address Fault Details

```
FCU Address Fault
Duplicate Address
Address 10
  15 on A &  23 on B
```

This screen shows details of any address fault present on the loop.

Line 2 shows the type of fault. Possible messages are

Duplicate address	- More than one field unit with the same address
Address too High	- A field unit has an address higher than the set address to scan up to
Zero Address	- A field unit has address zero (not permitted)

Line 3 shows the offending address.

Line 4 shows the position of the offending address or addresses. The above example indicates that a field unit at address 10 was found at position 15 out of port A and at position 23 out of port B. The display can show only two positions. If the same address occurs 3 or more times on the loop only the first two will be shown.

If there is more than one address fault on the loop this display will show the last one found.

The FCU map will always show the complete picture, i.e. every FCU found during loop configuration, including duplicates, however many there are

Commands available:

MENU	-	Return to previous menu
-------------	---	-------------------------

8.6 Setup Menu

Note: The Setup options can be PIN protected. See sections 8.1 and 8.6.8

8.6.1 Top Setup Menu

Port setup	1>Ports	
Loop options	3>Loop	4>Address Unit addresses
Set tag names	5>Tags	6>Time Date and time
ESD options	7>ESD	8>Security Access level settings

□ Commands available:

- 1** - Go to Port 1 setup page
- 3** - Go to Loop options page
- 4** - Change unit address used in communications with host computers, sequences and peer to peer communications
- 5** - Go to FCU Tag names page
- 6** - Go to Date and Time setup page
- 7** - Go to ESD configuration page
- 8** - Go to Access level and security page
- MENU** - Return to previous menu

8.6.2 Port Setup Menus

```

1>Port 1
2>Port 2
3>Port 3
    
```

The first screen allows the port to be set up to be selected, press 1, 2 or 3 for port 1, 2 or 3. Press Menu to return to the previous menu.

Once selected a screen similar to the following is revealed.

```

Port use  1>P1 Use  =Host
Protocol  2>Generic Modbus
Baud rate 3>19200   4>Par=Odd   Parity
                                                6> More options
    
```

For Port 1 the 'Use' option allows the port to be used for either communication with a host computer (Host) or for peer to peer communications (PtoP) between Pakscan IIS master stations. When peer to peer is chosen only the Baud rate option is shown and can be altered.

□ Commands available:

- 1** - Step around available use options. For Port 1 these are Host or PtoP
- 2** - Step round the available host communication protocols.
- 3** - Step round the baud rate options for the port. Choices are 38400,19200, 9600, 4800, 2400 and 1200.
- 4** - Step round parity options. These are Odd, Even, None or '0' (always set to zero).
- 6** - Go to alarm linkage screen
- MENU** - Return to previous menu

The remaining characteristics of the serial ports are fixed. These are:

- Port 1 - RS232/RS485, jumper selectable
- Port 2 - RS232/RS485, jumper selectable
- Port 3 - RS232 fixed
- All ports - Asynchronous, 8 bits/character, 1 stop bit

8.6.2.1 Alarm Linkage

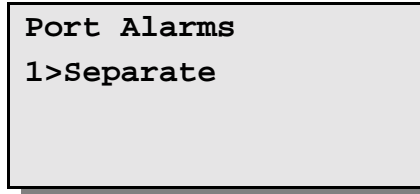

This screen allows port alarm handling to be configured. Alarms can either operate completely independently ('separate') for each port, or can be linked such that the same alarm information is always reported regardless of which serial port is used.

Alarms must be read and accepted before they can clear and return to normal. If configured as separate, alarm reading and acceptance must be done separately for each of the three ports. This ensures that the different hosts see all the alarms. When the alarms are linked, accepting an alarm on one port accepts the alarm on all the other ports as well.

The status screen displays for alarm indication cannot be linked to the serial communications alarm handling.

Linking the port alarm operations is useful in dual redundant serial link configurations between the master station and the host computer.

Note: Linking links all three host serial port alarm handling together. If Port 1 is set for peer to peer then linking links ports 2 and 3. The default option is Separated

□ Commands available:

1 - Toggle between "Linked" and "Separate".

MENU - Return to previous menu

8.6.3 Loop Setup Menu

	1>Speed (now) = 1200	Current speed
	2>Speed (new) = 600	Desired speed
	3>Number FCUs = 30	Highest address
Doubling enable	4>Doubling - OFF	5>
		More options

This page displays and controls options affecting the current loop.

The master station can program the speed used on the loop. Select the desired speed and it will be reprogrammed into the field units immediately the loop is next reconfigured.

The 'Doubling Enable' allows loop speed doubling to be enabled (ON) or disabled (OFF). If enabled, the master station automatically doubles the loop baud rate provided that it finds the loop is complete. This improves the scan time. In a few cases it may be necessary to disable this feature if it causes a high error rate on the loop.

□ Commands available:

- 1** - Step round the loop baud rate options. Choices are 110, 300, 600, 1200, and 2400.
- 2** - Step round the desired loop baud rate options. It is possible to select rates in the range one step up or two steps down from the current speed.
- 3** - Change the highest field unit address on the loop. The master station polls all field units up to this highest address. The scan time is minimised if polling is restricted to only those field units that may be present.
- 4** - Toggle between doubling enabled and disabled.
- 5** - Further options
- MENU** - Return to previous menu

Note: The loop scan time is minimised by setting the highest number to scan up to (the highest address). All the addresses in the selected range should be used and gaps in the address range should be avoided. Gaps or unused addresses cause the system to run more slowly as the unused addresses are still checked. In addition unused addresses will generate a communication failure alarm.

8.6.3.1 Further Loop Options

```
1>Retain data on
    Comms fail =OFF
2>IQ DV Convert=OFF
```

Two further settings for the data on the loop can be made from this screen.

There is an option to make the data held in the Modbus data base for each FCU retain the last value obtained prior to loss of communication with the device. Retaining the data (ON) has the effect of reporting the last known position of the valve. The alternate option (OFF) is that once communications is lost the data is cleared to all zeros. Clearing the data ensures that information cannot falsely report actuator position data. The default value is OFF.

The IQ DV Convert option can be used to ensure that 100% and 0% Desired Value outputs to the IQ actuators only is transformed into actions to make the actuator run to the fully open (100%) and fully closed (0%) positions. The message is converted from a DV command to an Open or Close command. This is useful for positioning actuators where it is possible that the valve will not fully shut or open when moved by only a small amount. When used for tight shut off valves with analogue position control only the setting should be ON, the default is OFF.

□ Commands available:

- 1** - Toggle Retain Last Data setting
- 2** - Toggle IQ DV Convert option
- MENU** - Return to previous menu

8.6.4 Unit Address Setup Menu

1>Masterstation= 1	Modbus slave address
2>Sequence/Interlock =128	Sequence address
3>Peer Number = 1	Peer node number

The master station responds to more than one Modbus unit address on each of its serial communication links. This allows the large amount of data the master station holds to be accessed and for additional security when setting up sequences.

The 'Masterstation' address is the unit address used to access the field unit and master station data as described in the Pakscan Modbus protocol document (S171E).

The 'Sequence/Interlock' address accesses the sequence programmes and interlock data in the master station. Reads and writes through this address programme and monitor the sequences and interlocks. It is not possible to access the Pakscan data through this address.

The Peer Number is the peer node number of the master station on the peer to peer highway when Port 1 is used for peer to peer communication.

□ **Commands available:**

- 1** - Set up the Pakscan data Modbus address
- 2** - Set up the Sequences programme access address
- 3** - Set up the Peer node number
- MENU** - Return to previous menu

Valid Modbus addresses are from 1 to 247 inclusive. The Sequence address must be different to the Modbus address number and must be above 128.

Valid peer node numbers are in the range 1 to 32. All the peers on the peer to peer highway must have different node numbers.

8.6.5 Tag Setup Menu

Master station tag	1>M/S Tag	MSTAG001
FCU address	2>FCU =	2
FCU's tag	3> Tag	FCUTAG02

This is the page for editing tag names that may be assigned to the master station and the field units.

□ **Commands available:**

- Edit master station's tag
- Change field unit address
- Edit field unit tag
- Go on to next FCU
- Go back to previous FCU
- Return to previous menu

Editing a tag:

An arrow appears beneath the character being edited

MSTAG001

^

□ **Commands available:**

- The Up and Down arrow keys are used to scroll through the characters which can be used in tag names. These are: 'A' to 'Z', '0' to '9', plus '-', and 'Space'. (Numbers 0 to 9 can however, be entered directly via the keypad)
-
- Abandon editing and start again
- Accept current character and move onto the next one
- Finish editing

8.6.6 Date and Time Setup

Date	1>Date 25/10/ 1
Time	2>Time 19:32:00

This page shows the state of the internal real-time clock. It is used within the sequence programming where the sequence requires a time or date action.

The date is displayed in the form Day/Month/Year.

The time is displayed in the form Hours:Minutes:Seconds using a 24 hour clock.

Commands available:

- 1** - Set date
- 2** - Set time
- MENU** - Return to previous menu

Setting the date:

On pressing '1', the 'Day' field is cleared and you can type in a new day. Correct a mistake by pressing the 'CLEAR' key. Finish entering the new day by pressing 'LOAD'. The 'Month' field will then be cleared, and so on.

Setting the time:

This is similar to setting the date.

8.6.7 ESD Options Setup Menu

```
ESD Options
1>Serial  Disabled
2>Keypad  Disabled
3>Input   Disabled
```

This page allows the user to select the ESD (emergency shutdown) function. ESD operation can be enabled or disabled separately for the serial ports, the keypad, and the hardware input. The default setting for all three controls is all inputs disabled.

□ **Commands available:**

- 1** - Enables / disables host port ESD input
- 2** - Enables / disables keypad ESD input
- 3** - Enables / disables hard wired ESD input, (terminals 32 and 33)
- MENU** - Return to previous menu

Note: A hard wired input ESD will cause a shutdown action when the contact input is open circuit. The individual actuator function on receipt of the ESD command is set within the actuator itself. Valves may close, open or stay put during an ESD event.

Once an ESD command has been issued to the actuator field units, local control is not available until a new command is sent from the master station to each actuator. The new command may be open, close or stop.

8.6.8 Keypad Security Options

```

Keypad Security
1>PIN In Use
2>PIN = ****
3>Access Level 3
    
```

A security code, PIN, can be set up to prevent unauthorised changes to the master station settings or field unit outputs. The second line shows '**PIN Not In Use**' if no PIN has been set up and '**PIN In Use**' once a PIN has been set.

The operations which are protected by the PIN are indicated by the 'Access Level' number on line 3. The meaning of these numbers is:

- ❑ **Access level:**
 - 1 - No protection. Setup can be changed and keypad commands entered without the PIN.
 - 2 - Setup protection. Setup changes require the PIN but keypad commands do not.
 - 3 - Setup and Command protection. Both setup changes and keypad commands require the PIN.
 - 4 - No keypad commands permitted whilst any host serial communication line is active. [If all serial communication links are inactive for 5 seconds then keypad commands can be entered provided the PIN is entered (as with level 3).]

- ❑ **Commands available:**
(All changes require either the Access level to be set to 1 or the current PIN to be entered)

- 1 - Change the requirement for inputting a PIN. When setting the PIN as 'Out of use' the previously programmed PIN is lost
- 2 - Enter a new PIN (when entered it will automatically place PIN 'In use'). Type in the required PIN. Numbers between 1000 and 9999 are acceptable. Mistakes can be corrected using the CLEAR key. Finish entering the PIN by pressing LOAD.
- 3 - Change the access level
- MENU - Return to previous menu

- ❑ **Entering a PIN from any screen:**
 - * - Pressing the * key reveals the PIN entry screen. Type in the PIN and then press the LOAD key. If the PIN is correct then press the MENU key to return to the previous page.

When an action requires the PIN to be entered a screen message 'PIN required' is displayed.

8.7 Field Unit Menus

The master station displays a screen appropriate to the type of field unit.

8.7.1 Actuator Field Unit Status Display

Digital status	OA1 ST0 MO0 FCUTAG01	Tag name
Digital status	CA0 MR0 MC0 1	FCU address
Measured value (position)	MV=100% 9>Alms=P	Alarm status
FCU commands	1>O 2>C 3>S 4>DV 5>	More options

Digital Status key:

(The display shows a '0' if the state is false and a '1' if it is true)

- | | |
|--|-----------------------------------|
| OA - Open Limit Switch | ST - Stopped in mid-travel |
| MO - Running Open | CA - Close Limit Switch |
| MR - Motor Running | MC - Running Closed |
| LB - appears if field unit is in loopback | |



Alarms key:

(The letter is present if the alarm has occurred)

- | | |
|---|---|
| F - FCU memory failure | j - Valve jammed |
| P - Power on reset | o - Valve obstructed |
| C - Communications failure | l - Local stop pressed |
| W - Watchdog reset | r - Monitor relay |
| s - Start/Stop failure | t - Thermostat tripped |
| m - Manual operation | c - Control Not Available |
| e - Motor running at end of travel | x - Travel time exceeded (IQ only) |
| a - Auxiliary override alarm (IQ only) | |

Commands available:

- | | | |
|-------------|---|---|
| 1 | - | Send Open command |
| 2 | - | Send Close command |
| 3 | - | Send Stop command |
| 4 | - | Send Set DV command. The master station prompts for the new DV before sending the command |
| 5 | - | Go to secondary data page |
| 9 | - | Go to alarm detail page (full text details of field unit alarms) |
| MENU | - | Return to previous menu |

	The Up and Down arrow keys are used to scroll through the field units
	
	CLEAR - Accept alarms





Note: When the Access Level is set to 3 or 4, to issue a command the correct PIN must be entered first. Pressing command keys 1, 2, 3, or 4 causes a confirmation screen to appear before the command is sent.

8.7.2 IQ Actuator Second Status Page

Current torque	Torq=85%	FCUTAG01	Tag name	
Auxiliary inputs	Aux1=1	Aux2=0	1	FCU address
	Aux3=0	Aux4=0	LoBat	Battery status
	1>Torque	2>		More options

This screen shows the current torque value and the status of the 4 auxiliary digital inputs on an IQ actuator. The flag "LoBat" is displayed if the field unit is reporting that the battery within the actuator is low.

Commands available:

-  - Go to next field unit
-  - Go to previous field unit
-  - Go to torque display screen
-  - Go to secondary data page
-  - Return to previous menu

8.7.3 IQ Historic Torque Displays

```

Open Torq   FCUTAG01
101  83  74  62   1
 59  67  81  98<Open
1>Close 2>Reload 3>

```

```

Close Torq  FCUTAG01
 96  85  70  58   1
 57  65  78  92<Open
1>Open 2>Reload 3>

```







These screens show 8 values of torque for the actuator travelling in the opening or closing direction. They are the values that have been most recently received from the field unit. The 8 values refer to the actuator motor torque at the following positions of the actuators stroke, 6%, 19%, 31%, 44%, 56%, 69%, 81% and 94%. Thus on the "Open Torque" example screen shown above, 101% is the torque value at 6% open, 83% is the torque value at 19% open, etc.

Torque values are displayed as percent of rated torque and have a range of 0 to 120%.

Note: If the actuator has been moved over part of its stroke, e.g. from 20% to 60% open, then the torque values outside that range may have been reset to zero.

If the IQ field unit has been programmed with a torque filter factor of "000" then these 8 torque values are automatically returned to the master station once the actuator has travelled from one end of travel to the other. However, if the filter factor has been set to a value greater than "000" these values are only returned when the reload button (2) is pressed. Pressing reload will also cause the master station to fetch the torque values when the actuator has not travelled from end to end, irrespective of filter factor setting.

□ Commands available:

-  - Go to next field unit
-  - Go to previous field unit
-  - Toggle between opening and closing torque screens
-  - Reload new torque values
-  - Go to secondary data page
-  - Return to previous menu

8.7.4 Flowpak Actuator Field Unit Status Display

Digital status	OS1 ST0 TO0 FCUTAG01	Tag name
Digital status	CS0 TR0 TC0 1	FCU address
Measured value (position)	MV=100% 9>Alms=P	Alarm status
FCU commands	1>O 2>C 3>S 4>DV 5>	More options

Digital Status key:

(The display shows a '0' if the state is false and a '1' if it is true)

- | | |
|--|-----------------------------------|
| OS - Open Limit Switch | ST - Stopped in mid-travel |
| TO - Travelling Open | CS - Close Limit Switch |
| TR - Valve Travelling | TC - Travelling Closed |
| LB - appears if field unit is in loopback | |

Alarms key:

(The letter is present if the alarm has occurred)

- | | |
|-----------------------------------|----------------------------------|
| F - FCU memory failure | j - Valve jammed |
| P - Power on reset | o - Valve obstructed |
| C - Communications failure | l - Local stop pressed |
| W - Watchdog reset | r - Monitor relay |
| s - Start/Stop failure | t - Low pressure |
| m - Manual operation | c - Control Not Available |

Commands available:

- | | | | | | | | | |
|-------------|--|---|---|---|---|--|-------|-----------------------|
| 1 | - Send Open command | <table border="0"> <tr> <td style="text-align: center;">↑</td> <td>The Up and Down arrow keys are used to scroll through the field units</td> </tr> <tr> <td style="text-align: center;">↓</td> <td></td> </tr> <tr> <td style="text-align: center;">CLEAR</td> <td>CLEAR - Accept alarms</td> </tr> </table> | ↑ | The Up and Down arrow keys are used to scroll through the field units | ↓ | | CLEAR | CLEAR - Accept alarms |
| ↑ | The Up and Down arrow keys are used to scroll through the field units | | | | | | | |
| ↓ | | | | | | | | |
| CLEAR | CLEAR - Accept alarms | | | | | | | |
| 2 | - Send Close command | | | | | | | |
| 3 | - Send Stop command | | | | | | | |
| 4 | - Send Set DV command.
The master station prompts for the new DV before sending the command | | | | | | | |
| 5 | - Go to secondary data page | | | | | | | |
| 9 | - Go to alarm detail page (full text details of field unit alarms) | | | | | | | |
| MENU | - Return to previous menu | | | | | | | |

Note: When the Access Level is set to 3 or 4, to issue a command the correct PIN must be entered first. Pressing command keys 1, 2, 3, or 4 causes a confirmation screen to appear before the command is sent.

8.7.5 General Purpose Field Unit Status Display

	DIN1->DIN8	FCUTAG01	Tag name
Digital inputs	00001111	1	FCU address
Measured value 1	A1= 75% 9>Alms=P		Alarms
Measured value 2	A2= 50%	1>More	Commands page



The status of the eight digital inputs are displayed as eight 0's or 1's. A 1 indicates that the input is true.

The alarms code letters are the same as for an actuator field unit. However, only memory failure (F), comms failure (C), power on reset (P) and watchdog timer (W) are valid alarms. As with the actuator page there is a full text display of the alarms that may be found by pressing 9.

- ❑ **Alarms key:**
(The letter is present if the alarm has occurred)
 - F** - FCU memory failure
 - P** - Power on reset
 - C** - Communications failure
 - W** - Watchdog reset

The commands are accessed by going to a second page (press 1). This is because there is more data than for an actuator field unit.

- ❑ **Commands available:**
 - 1** - Go to commands page
 - 9** - Go to alarm detail page (full text details of field unit alarms)
 - MENU** - Return to previous menu

	The Up and Down arrow keys are used to scroll through the field units
	
CLEAR	CLEAR - Accept alarms

8.7.5.1 Second Page for General Purpose Field Unit

Pulse counter	Pulses= 44 FCUTAG01	Tag name
Relay commands	1>R1=0 2>R2=0 1	FCU address
	3>R3=0 4>R4=0	
Analogue output	5>Aout= 0% 6>	Block and parameter screen

Digital input 1 on a GPFCU can be used as a pulse counter. The master station screen will count pulses up to 9999 before rolling over to 0 and starting again.

Options 1 to 4 prompt the user to Energise (1) or De-energise (0) the relay before the command is sent.

Note: The general Purpose Field Unit may be configured for fleeting relay outputs, in which case it will not action the de-energise commands, and if the relays are energised their status will always display 0.

Option 5 prompts the user to enter a data value for the analogue output in the range 0 to 100 %.

□ Commands available:

- Go to next field unit
- Go to previous field unit
- Operate relay 1
- Operate relay 2
- Operate relay 3
- Operate relay 4
- Set analogue output
- Go to secondary data page
- Return to previous menu

Note: When the Access Level is set to 3 or 4, to issue a command the correct PIN must be entered first. Pressing command keys 1, 2, 3, or 4 causes a confirmation screen to appear before the command is sent.

8.7.6 IQ Analogue Input Field Unit

Analogue input channel 1	A1= 12%	FCUTAG01	Tag name
Analogue input channel 2	A2= 34%	1	FCU address
	9>Alms=P		Alarms
		5>	Block and parameter screen

The IQ actuator can contain two field units, each with their own loop address. The IQ Analogue Input field unit collects two analogue signals for display and reporting.



The alarms code letters are the same as for an actuator field unit. However, only memory failure (F), comms failure (C), power on reset (P) and watchdog timer (W) are valid alarms. As with the actuator page there is a full text display of the alarms that may be found by pressing 9.

- ❑ **Alarms key:**
(The letter is present if the alarm has occurred)
 - F** - FCU memory failure
 - P** - Power on reset
 - C** - Communications failure
 - W** - Watchdog reset

There are no commands associated with this page, though the block and parameter screen does allow access to the parameters associated with reporting.

- ❑ **Commands available:**

- 5** - Go to secondary data page
- 9** - Go to alarm detail page (full text details of field unit alarms)
- MENU** - Return to previous menu





	The Up and Down arrow keys are used to scroll through the field units
	
CLEAR	CLEAR - Accept alarms

8.7.7 Communications Failure Display

FCUTAG01	Tag name
1	FCU address
Alarm : Comms Fail	Alarm
5>	Block and parameter screen

This display is put up if the field unit is not in communication with the master station.

□ **Commands available:**

-  - Go to next field unit
-  - Go to previous field unit
-  - Go to secondary data page
-  - Return to previous menu

8.7.8 Field Unit Status Secondary Data

Block	1>Block= 5 FCUTAG01	Tag name
Parameter	2>Para = 2 1	FCU address
Data	3>Data = 16	
Name	Motion Inhibit Timer	

This page allows the user to read and change parameters in a field unit. Data in field units is organised into 32 blocks each of 8 parameters, the parameters within each block being related to each other, e.g. block 5 contains parameters which are connected with the position control mechanism of an actuator.







Parameters are selected by setting the appropriate block and parameter numbers. The parameter name and its current value are then displayed. Values are displayed and entered as decimal numbers.

On entry of a parameter number the master station will send a message to the field unit to read the required data, which will then be displayed.

On entry of new parameter data in a valid parameter, the master station will write that data to the field unit. The master station does not check whether the data is valid, only that the parameter may be written to. After writing, the master station will read back the parameter. Writes to Block 1, and to Parameter 0 of any Block, are not permitted from the master station.

Refer to S171E: Pakscan Master Station Modbus Interface Specification for Communication via RS232 or RS485 for field unit data allocation information and details of the meaning of each parameter.

□ Commands available:

-  - Go to next field unit
-  - Go to previous field unit
-  - Enter block number, numbers between 0 and 14 are valid
-  - Enter parameter number, numbers between 0 and 7 are valid
-  - Enter new parameter data (in decimal)
-  - Return to previous menu

LOAD

Press LOAD after entering a new value to complete the action and update the screen.

8.8 Sequence and Interlock Menus

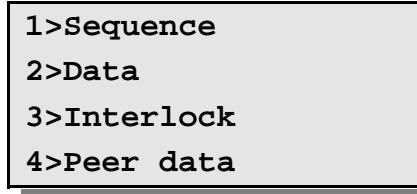

This section describes the information displays for sequences and interlocks. To fully understand the data provided, detailed knowledge of the programmed sequences and the data structures they are using is required.

The first level screen shows the menu for the possible examination areas related to sequences, interlocks and peer to peer data.

□ **Commands available:**

- 1** - Go to Sequences information page
- 2** - Go to Sequences Data information page
- 3** - Go to Interlock data page
- 4** - Go to Peer Data information page
- MENU** - Return to previous menu

8.8.1 Sequence Information

Sequence number	1>Sequence 1	
Sequence mode	2>Auto	
Step	Step= 134 Phase= 10	Sequence phase
Message	Wash phase	

There may be up to 80 sequences in the master station, so the range of sequence numbers permitted is 1 to 80.

❑ Sequence Mode:

Each sequence may be in one of the following modes:





Not Loaded	(no sequence loaded)
Loading	(sequence currently being downloaded)
Manual	(sequence loaded but not running)
Auto	(sequence running)
Computer	(sequence running)
Single Step	(sequence in single step mode)

The **step number** indicates the presently being executed step of the sequence. It is the absolute step number, not the step within the sequence itself (not the offset from the beginning of the particular sequence).

The **phase** of a sequence is a user programmed number, which can be used to divide up a sequence into a number of parts.

The **message** is text information that may be included in the sequence to indicate the activity being carried out on the currently displayed step.

❑ Commands available:

	-	Go to next sequence
	-	Go to previous sequence
	-	Enter Sequence number
	-	Change sequence mode
	-	Return to previous menu



Press LOAD after entering a new value to complete the action and update the screen.

8.8.2 Sequence Data

General register number	1>GR	1 =	1 <4	General register contents
Sequence flag number	2>SF	1 =	OFF <5	Sequence flag state
	3>Database Reg		0	Register number
		=	512	Register contents

Some data items can be examined with this screen.

The values of general registers, sequence flags and Modbus database registers from the sequence database are displayed.

There are 600 general registers, which can be used singly to hold a 16 bit signed number or in pairs to hold a 32 bit signed number. There are 1024 sequence flags that can be 'On' (1) or 'Off' (0).

All data relating to sequences and interlocks is held in Modbus registers. Detailed knowledge of the register organisation is required to make use of this facility. Refer to the SCT Internal Addressing Tables in the SCT manuals for details of this data base.

□ Commands available:

1	-	Enter General Register number	<div style="border: 1px solid black; padding: 5px; display: inline-block;"> LOAD </div> Press LOAD after entering a new value to complete the action and update the screen.
2	-	Enter Sequence Flag number	
3	-	Enter Modbus register number, numbers from 0 upwards are valid	
4	-	Change contents of specified General Register	
5	-	Change state of specified Sequence Flag	
MENU	-	Return to previous menu	

Note: General Registers are displayed and entered on this screen as unsigned 16-bit integers. However, within Sequences, General Register values are interpreted as signed integers. The reason for this difference is that the master station keypad has no 'minus' key.

8.8.3 Interlock Data

Interlock status	1>Interlocks= ON
Interlock failure	Failed at 5
	5 PO 24 Open
Failure details	PI 23 OAS<>1

This page provides details of the operation of interlocks within the Pakscan IIS master station. Particular outputs can be interlocked with status bits from other field units, or with items from the sequence data base such as flags. Interlocks can only be set externally using the SCT programme and then down loaded to the master station.

The first line shows whether any interlocks are active.

The remaining three lines show details of the most recent (if any) interlock failure to occur. If there has been no failure they will be blank. It is necessary to refer to the interlock set up information from SCT to make full use of the presented data.

Line 2 shows which interlock failed last.

Line 3 shows which output was affected.

Line 4 shows the first interlock condition, which caused the failure.

On lines 3 and 4 inputs and outputs are shown as a 2 letter identifier, plus field unit number, plus input or output identity.

□ Commands available:

- | | | |
|------|---|---|
| 1 | - | Toggle interlocks between On and Off. Note that interlocks can only be turned on provided that some interlocks have been defined. |
| MENU | - | Return to previous menu |

8.8.4 Peer Data





Peer number	1>Peer Number = 2	
Item from peer's data	Peer data Size= 4	Size of data from peer
	2>Item = 1	
	Data = 32767	Value of specified item

This screen displays details of data received from other nodes on a peer-to-peer network.

Line 2 shows the number of 16-bit registers of peer data received from a node. Zero registers is possible if a node has no peer data to export.

Lines 3 and 4 allow the values of specific registers from a peer to be displayed. Register numbers are 1-based. Values are displayed as signed integers with a range of -32768 to +32767.

Commands available:

-  - Go to next peer node
-  - Go to previous peer node
-  - Select peer node number
-  - Select item from peer
-  - Return to previous menu

 Press **LOAD** after entering a new value to complete the action and update the screen.

9 SETTING PARAMETERS AND DOWNLOADING PROGRAMMES

IMPORTANT SAFETY PRECAUTIONS

If you are unable to secure the connected equipment into a safe state then disconnecting the loop cable from both ports of the master station will prevent plant operation.

When setting the parameters for a particular master station or downloading a sequence configuration it is essential to protect any connected plant from inadvertent operation. Ensure that the connected actuators are in Local control (as this will prevent them from moving under Pakscan control EXCEPT for ESD - remember that ESD is latched in a field unit), or Local Stop is selected, or locked in 'Hand'. Also ensure that any other plant equipment connected to field units is either able to be operated safely, or is prevented from operating.

On the master station ensure that the ESD option is either disabled or that the input is a closed circuit (by either a link or the actual input contact).

These simple precautions will make sure that if you make a mistake in the setting of the master station parameters no plant action will result.

The plant should only be returned to an operational state once you are satisfied that the parameters are correctly set or the programme operates correctly.

BEFORE YOU START

Make sure that all the hardware selections match those required for the final equipment. Set all the jumper links and switches as required.

Make sure the master station is powered up and the screen is illuminated.

You can only make changes to the setting of the internal parameters if the PIN is known or disabled or the Access level is low enough. (When the master station leaves Rotork its PIN protection level is disabled, however, it may have been enabled by a third party before arriving on site). Make sure you can gain access by knowing the PIN or knowing what PIN is to be set.

9.1 Initial Decisions

The setting up of the user variable parameters in a master station requires detailed knowledge of what you want the system to do.

You must have available answers to the following questions:

- a) Where applicable, for communication to the host system what Protocol will you be using, what Baud rate is needed, what parity is needed. If you have two hosts you need this data for both and also if the alarms data bases should be separate or linked.
- b) Where Peer to Peer communication is required, the peer number of each master station will be pre-determined by the sequence control strategy.
- c) For the 2 wire loop, how many field units are connected, or to be connected, and what is the highest address used for a field unit. What is the loop baud rate? Do you want to run the loop at its maximum performance?

9.2 Communication Ports

The master station may be configured for different functions on each of its three communication ports. However the Modbus address of the master station relates to all the ports, they cannot differ. In addition the master station has a sequence address as well as a host comms address and these two must never be the same. The peer number is independent from the Modbus and Sequence addresses.

Setup	
Addresses	Host, Sequences and Peer to Peer
Comms Protocol	Generic Modbus Yokogawa Modbus Honeywell PLCG Modbus Honeywell SI Modbus
Baud Rate	1200, 2400, 4800, 9600, 19200, 38400
Parity	Odd, Even, None, always 0
Port Alarms	Linked, Separate

The settings to make are in the Master Station Setup Menu as described in section 8.6. To reach the required screens from the opening top menu screen, press '1' to select the master station side of the menu structure. The next screen revealed shows the options for what to do next. Press '5' to select Setup. Changes to the settings can only be made if the PIN is entered or the Access Level is set to 1, though the settings may be reviewed at any time. The next screen displayed is as shown in section 8.6.1 and this has under option 4 the ability to set the master station Modbus address, Sequence address and Peer node number.

Press '4', then '1' and enter the number to be used as the Modbus address, when it is correct press 'LOAD'. Repeat the exercise for the sequence address and the Peer node number (if per to peer data exchange is not being used then the default value of 1 can be left). The screen is refreshed, shows the selected address and a message briefly appears informing you that the new setup is loaded. Return to the previous menu by pressing 'MENU'.

From the master station setup menu screen (8.6.1) press '1' to select Ports (8.6.2), then '1' to select port 1. The revealed screen shows the selectable options for Port 1.

Pressing '1' toggles between Host and Peer to Peer use. If Peer to Peer is chosen then the inter unit comms speed is also available for selection.

Pressing '2' will scroll round the available protocols, select the required. Note that the Rotork PC based plant control package, InVision, uses the Generic Modbus setting.

Pressing '3' steps round the baud rates and '4' selects the parity.

When the settings are correct, press 'MENU' to return to the previous page. The chosen settings will only become active once you leave the 'set up' screen. Press '1' and then '2' to select Port 2.

The screen is very similar to the one for Port 1 except that there is no Peer to Peer option; the remaining choices are the same. Make the settings required in the same way as for Port 1.

Similarly make the selection for the settings for port 3, remembering that Port 3 is available for RS232 only.

Having set the port communications parameters it is then necessary to set the alarm linkage if dual comms to the host is being used. Press '6' to gain access to the screen shown in section 8.6.2.1. Linked alarms will operate such that accepting an alarm using comm port 1 will also cause it to be accepted in the data base serving comm port 2 and 3 (and similarly for all the combinations of 1, 2 and 3). If the host system is using redundant communications with two links then the option is best set to 'Linked'. If two or more independent hosts are accessing the master station then the setting should be 'Separate'.

Once the settings are correct, press 'MENU' to install the settings and return to the previous page.

9.3 Loop Data

In section 7.4 the various pieces of information relating to the loop wiring and the cable parameters were measured and recorded. When it comes to setting the master station Loop Data the Loop Speed has to be compatible with that data (also the individual field units must be set to match the master station setting). The following table indicates the Loop Baud Rate that may be used for various values of cable resistance and capacitance.

Setup	
Loop Speed	110, 300, 600, 1200 or 2400 baud
Number of FCU's	In the range 1 to 32
Doubling	On or Off

□ Pakscan Cable Capacitance

Baud Rate	R max (ohms)	C max for 32 FCU system (μF)①	C max for 20 FCU system (μF)①	C max for 10 FCU system (μF)①
110	500	4.43	4.45	4.47
300	500	2.03	2.05	2.07
600	500	1.47	1.49	1.51
1200	500	0.53	0.55	0.57
2400	500	0.23	0.25	0.27

① Each field unit has a capacitance of 2.2nF
The C max figure given is the maximum value for the cable capacitance without the field units connected.

Note: You should not attempt to run the system with cable resistance and capacitance values above those specified for the chosen baud rate as communication may not be possible.

To set the loop parameters, start from the Top Setup Menu (as shown in section 8.6.1). If the Ports have just been set then this is the screen displayed.

Press '3' to select Loop Options.

The screen revealed is as shown in section 8.6.3.

Press '2' to step around the available baud rates, when the correct one is revealed leave it there.

Press '3' to set the number of the highest address for the connected field units on the loop. Enter the number of the highest address with the keypad numbers and press 'Load' to confirm the setting. The Master Station will then only poll around field units up to and including this address number. Note that the Master Station is a 32 channel unit and cannot have the highest address set above 32.

Press '4' to toggle between Baud Rate Doubling 'On' or 'Off'. Most systems will probably want to be run with doubling on, as this improves the speed of communication on the loop by a factor of 2. However whilst commissioning the system it may be better to start with this option set to 'Off'. It can always be change to 'On' once the loop is successfully operating. Take care when upgrading from an older Pakscan II system as the baud rate doubling function will only operate successfully if all the field units are also upgraded to Pakscan IIE standards.

Once these three parameters are set they will only become active when this screen is left by pressing 'MENU'. This returns to the Top Setup screen shown in 8.6.1.

9.4 Tag Names

It is possible to insert a tag name for every field unit, and also for the master station itself. Tag numbers help maintenance in checking that they have the right MOV.

Option '5' on the screen shown in section 8.6.1 selects the Tag Name Setting screen (as shown in section 8.6.5).

By pressing buttons '1', '2', or '3' you can select which field to edit. To select a different field unit address, simply use the 'Up' or 'Down' arrow keys. Section 8.6.5 explains how to select the letters and characters for a tag name.

9.5 Date and Time

From the 'Top Setup Menu' as shown in section 8.6.1, select option '6' to enter the 'Date and Time Setup'.

The screen revealed is as shown in section 8.6.6. Pressing buttons '1' or '2' allows the date and time settings to be modified. In most cases the clock will have been set to U.K. or U.S. time prior to shipment. If daylight saving time changes are in use in your territory then the clock will need altering when this local time change occurs. The clock can be used by the sequencer programmes and should be set accurately.

9.6 ESD Configuration

From the 'Top Setup Menu' as shown section 8.6.1, select option '7' to enter the 'ESD Options Setup'.

The screen revealed will be as shown in section 8.6.7. It is possible to enable or disable the ESD action from the 3 possible sources on the system. The default is to disable ESD on all inputs.

Pressing '1', '2', or '3' will toggle the mode for the labelled input between enabled and disabled. This function allows the keypad ESD input to be inhibited, in which case the prompt is removed from the master station commands screen. Similarly the remote terminal input or serial control inputs may be inhibited.

Note: It is always recommended that the external link on terminals 32 and 33 is made even if the ESD input is not in use so as to ensure that the inadvertent changing of these settings does not produce an unwanted ESD action.

9.7 Security Access Level

System access security is provided using two parameters, a PIN and the Access level. In general no setup data or commands to the actuators can be issued from the keypad unless the required PIN has been set. If access has been gained using the PIN, then the future requirement for a PIN can be removed, or the level of access required for issuing commands and altering the setup altered.

At any time the PIN may be entered. Pressing the * key reveals the PIN entry screen. Successful entry is acknowledged whilst an unsuccessful entry prompts for a retry. PIN's may be any number in the range 1000 to 9999.

From the 'Top Setup Menu' as shown section 8.6.1, select option '8' to enter the 'Security Setup'. The screen revealed will be as shown in section 8.6.8. It is possible to enable or disable the requirement for a PIN or change the Access level from this screen as well as define a new PIN.

The PIN may be placed in or out of use by option 1. A new PIN may be specified using option 2 and the access level altered using option 3. If the PIN is out of use then the access level is automatically at level 1 - no restrictions on what may be done via the keypad.

Set the required PIN by pressing '2' and entering the required number. It must be 4 digits in the range 1000 to 9999. Once it is entered make sure that the access level is set correctly.

9.8 Final Checks

Once all the parameters are set, revisit each screen for setting the Ports, Loop, Tags, Time ESD and Access settings to make sure they have loaded correctly, and that there are no mistakes.

As a final operation, note all the settings on a record sheet such as that shown in Section 12.

9.9 Downloading Sequence Programmes

Sequences may be downloaded to the master station using any of the three serial comms ports. The programme to be downloaded must be written using the SCT software provided with the sequence option of the master station. The PC on which this task is performed is then connected to the master station via a serial link. The settings of the SCT programme require that the address and certain other data about the master station is set into the configuration. The master station must be set to Generic Modbus protocol on the port that is being used for communication to the SCT computer.

More information on downloading the programme is available in the SCT guide.

10 COMMISSIONING THE SYSTEM

IMPORTANT SAFETY PRECAUTIONS

In order to fully commission the Pakscan Loop it is necessary to ensure that all the system's valves are allowed to be opened and closed. Also any ancillary devices such as pumps and stirrers must be allowed to operate. Without this capability it is impossible to check all the functions of the total system.

It may be that valve movement and pump operation is not permissible, as the plant may already be operational in a manual mode. In this case it will only be possible to test out parts of the Pakscan system. However if the connected field units are to operate devices on a 'live' plant it is vital to secure the connected equipment into a safe state. Ensure that the connected actuators are in Local control or locked in 'Hand' (as this will prevent them from moving under Pakscan control) and any other plant equipment connected to field units is either able to be operated safely, or that the outputs are prevented from operating the connected equipment. Don't forget that an actuator set to Local will still respond to an ESD signal and may move the valve. It is also advisable to ensure that all the connected equipment is safe, for example in Local Stop, whenever the loop is re-configured.

The plant should only be returned to its original state once the loop is operating correctly.

Commissioning of sequences should only be attempted after the loop has been successfully commissioned.

BEFORE YOU START

In checking the loop resistance and capacitance the operating loop baud rate was determined. This baud rate must be set as the operating speed for ALL the connected field units. Note that the 'Doubling' option described in 9.3 above is an independent function, the cable parameters and number of field units present determine the baud rate selection.

Set all the field units to match the master station Loop Baud Rate.

10.1 Checking Individual Field Units.

Use a Paktester to verify that each and every field unit is correctly set for Baud rate and Address. Where there are options for the setting of the field unit make sure these are adjusted correctly. Refer to the Paktester manual (S178E) for information regarding these adjustments. All field units, including those simply used for full open and full close duty, report analogue values for valve position. Whenever this data is not required, the Analogue Update Time and Deviation settings should be set to turn off this reporting, or to the maximum acceptable value. If these parameters are not correctly set then the field unit will be sending analogue messages far too often and slow down the remaining data comms.

Pay particular attention to selecting the correct function for General Purpose field units, and also for the settings for Analogue Update times and Deviation settings for all field units where analogue data is collected.

Make sure that no two field units on the loop have the same address, and that no field unit has an address set higher than that selected as 'the highest address' - see section 9.3.

When setting and checking a field unit remember that the Paktester will only communicate to one field unit at a time, the one to which it is connected. Also remember that the address and baud rate can only be altered if the field unit is in loopback.

10.2 Checking the Loop Itself

The most common problem in commissioning is that the field wiring is incorrectly made. If the cable is not connected correctly between the Output side of one field unit and the Input side of the next then the loop will fail to operate. As field units which are powered 'off' divert the signal directly from input to output a simple resistance check will not reveal this cabling error. Similarly if the cable is 'twisted' so that the common wire is not connected to all the common terminals this will also not be revealed by a simple resistance check.

It is extremely important to check all the wiring to ensure it is correctly connected throughout the loop.

Hint:

The loop wiring can often be checked by using the Paktester on the end of the cable. Power 'on' all the actuators and successively power them 'off' starting with the one nearest the master station. [Page 6 of the Paktester manual (S178E) has a picture showing how to connect the Paktester.]

This is only possible if the total loop resistance is **less than 200 ohms**.

Disconnect the loop wiring from the master station; connect the Paktester to the wires that were connected to Port A of the master station. Ensure that all the actuators are switched on. The Paktester should be able to establish communication with the nearest field unit to the master station. Once communication is verified, switch off the nearest field unit, and repeat the communication test with the next field unit. Successively power 'off' each field unit 'forwards' round the loop until communication has been verified with all the field units. Make a note of the order of the addresses of the field units on the loop (i.e. a Map).

Establishing communication in this way verifies the loop cabling, except for the final connection from the last field unit back to Port B of the master station. To check this final part of the wiring connect the Paktester to Port B wires (ensuring the correct polarity) and establish that you can communicate with the field unit nearest Port B.

❑ Checking the Loop with the Master Station

Initially set the Loop Driver circuits to deliver maximum loop voltage. Do this by turning the two potentiometers RV101 and RV102 fully anti-clockwise.

Connect Port A wiring only to the master station, leave Port B disconnected. This time make sure that all the field units except the one furthest away are powered off. Select the Master Station Status screen, go to the Master Station Commands screen, and Reset the Loop by pressing '1'. Return to the Status screen (by pressing 'Menu').

The status screen will show 'Waiting for Loopbacks 1', and be followed by 'Finding FCU A', 'Finding FCU B', 'Waiting for Loopbacks 2', 'Loopbacks Off A', 'Loopbacks Off B' and finally 'Loopback On'.

Now press '1' to select the master station commands, followed by '4' to select the diagnostic screen. This is illustrated in section 8.5.4. If all is well on the loop it should show that the reason for the last loop configuration is 'Reset Command' and that there is a loopback at the last field unit.

As the master station progresses through the configuration of the loop it moves through a number of steps:

1. It waits for all field units to revert to loopback on. - Waiting for Loopbacks 1
2. It locates each field unit connected to port A - Finding FCU A
3. It locates each field unit connected to port B - Finding FCU B
4. It then waits again for all field units to revert to loopback on - Waiting for Loopbacks 2
5. It removes loopbacks from field units on A as far as the last one on the loop which it leaves in loopback - Loopbacks Off A
6. It removes loopbacks from field units on B as far as the last one on the loop which it leaves in loopback - Loopbacks Off B
7. It reports the loop status - Loopback On or Off

The master station should have established communication with the furthest field unit. Return to the Master Station Status page (section 8.3), press 2 to select Field Units, and select the address for the powered on field unit by using the 'Up' or 'Down' arrow key. The status screen (as illustrated in section 8.7.1) will show if communication is established.

Now switch on the next nearest field unit, change the display to show its status and check that communication is established with it and the last field unit. There is no need to reset the loop as this unit has been introduced between the master station and the field unit in loopback and communication with it should be quickly established. If there is a fault on the loop wiring this will prevent the master from communicating to this field unit.

Successively progress backwards round the loop powering 'on' each field unit and establishing communications. Faults should be corrected as you go. Switch the display between the field unit being checked and the Master Station Status screen to make sure that communications are satisfactory. If the master station fails to locate a field unit, or goes into the reconfiguration process use the diagnostic screens to establish why. Finally you will end up with all the field units in communication with Port A.

Next connect the Port B wires and disconnect the Port A wires, reset the loop and check that there is only one loopback at the field unit nearest Port A.

Finally re-connect the Port A wires, reset the loop and check that there are no loopbacks anywhere, and that all the field units are in communication with the master station. Verify that status changes in the field are reported to the appropriate field unit screen, and that commands can be issued to every field unit.

10.3 Checking System Performance

In section 9.3 it was recommended to set Baud Rate Doubling 'OFF'. Once the loop is up and running this may be changed to 'Doubling On'.

10.3.1 Setting the Loop Driver Voltages

In most systems it is not necessary to trim the loop driver card voltages to optimise the performance. However for maximum performance the voltages can be set to match the loop cable parameters. The ideal voltage depends on the loop resistance and the number of field units attached:

$$\text{Ideal Voltage} = \frac{\text{Resistance}}{50} + \frac{\text{No.FCU's}}{50} + 3 \text{ Volts}$$

The two potentiometers, RV101 and RV102, can be set by either of two methods.

❑ Method 1

Turn both potentiometers fully anti-clockwise. This sets the voltage to the maximum.

To set Port A's voltage. Disconnect the two wires from Port B and re-configure the loop. With the loop running, turn Port A's potentiometer RV101 clockwise until the A LED on the door just goes out. Then turn the potentiometer back slightly until the A LED is fully lit once more.

To set Port B's voltage. Reconnect the two wires at Port B, and disconnect the two wires at Port A. Re-configure the loop. With the loop running, turn Port B's potentiometer RV102 clockwise until the B LED on the door just goes out. Then turn the potentiometer back slightly until the B LED is fully lit once more.

Reconnect the two wires at Port A. Re-configure the loop and leave it running for a few minutes. Check that communication with all field units is satisfactory.

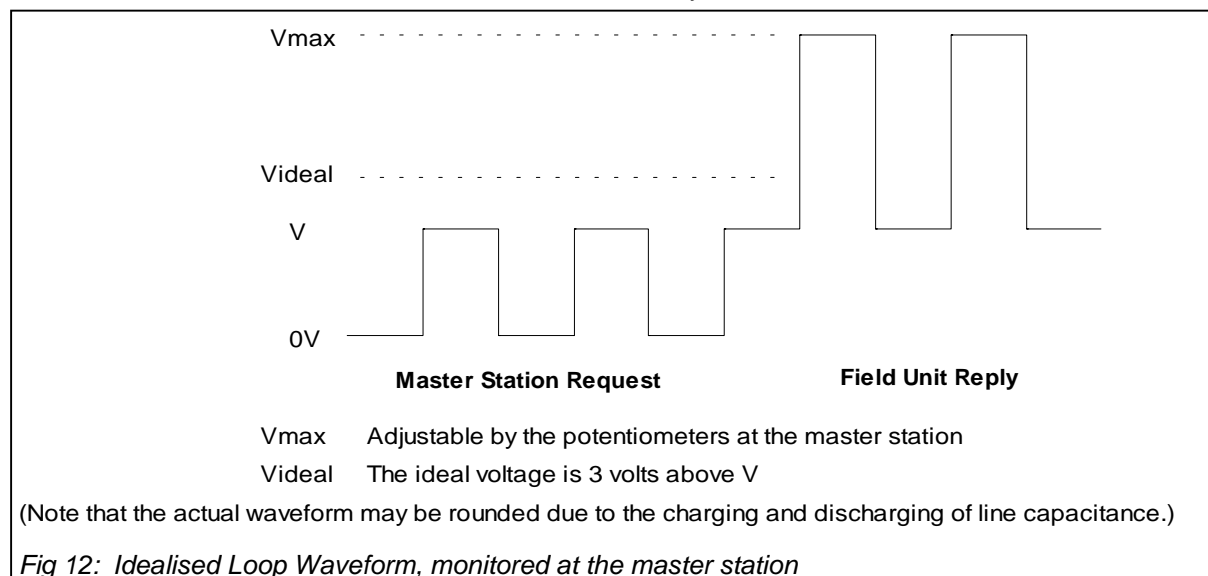

❑ Method 2

With the field units powered up the master station should be able to communicate to all of them once the loop has been configured. If communications are not fully established see Section 10.7 for fault finding hints.

The line drive voltage can now be set with the aid of an oscilloscope. Allow the master station to configure the loop and ensure all field units are in communication without any loopbacks.

Monitor across Port A loop wires and trim V_{max} down to V_{ideal} by adjusting Port A's potentiometer RV101. (See Fig 12:)

Remove Port A wires, allow reconfiguration to finish, again checking all field units are in communication with only one unit in loopback (which should be the one that was connected directly to port A). Monitor across Port B loop wires and trim V_{max} down to V_{ideal} by adjusting Port B's potentiometer RV102. Remove the oscilloscope and replace the field loop wires and reset the loop.

10.4 Setting Up Peer to Peer Communications

Peer to Peer communication allows a number of Pakscan IIS master stations, **up to 32 maximum**, to exchange data for use in sequences created and downloaded using SCT. The data highway must use Port 1 on the master station and 2 wire RS485 mode (ensure the links and switches are correctly set for this mode). The data rate may be set to any of the selectable baud rates, depending on the distance between the master stations. All the master stations must have a unique peer number.

The peer node with the lowest number takes control of the network and issues the requests for the other peers to issue their data. All peers accept the messages and react to the data assigned to them by the SCT program. If the peer node with the lowest number is switched off, or fails, then the control task is taken up by the peer with the next lowest number.

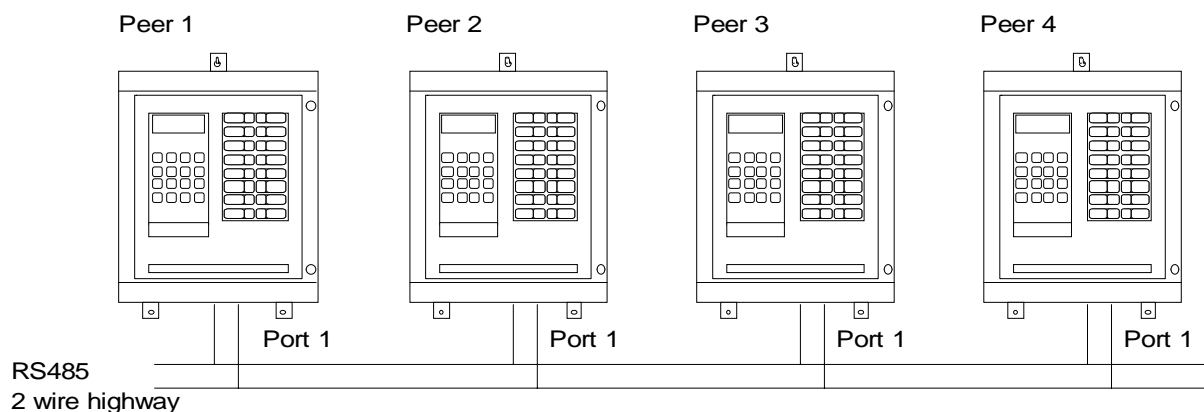

Fig 13: Peer to Peer master station communication

- ❑ All master stations must have different peer numbers
- ❑ All master stations must use Port 1 for communication
- ❑ Communication **must** use 2 wire RS485

10.4.1 Connections

The RS485 cable connects the master stations together as follows

Peer 1		Peer 2		Peer n
TxA+	-----	TxA+	-----	TxA+
TxA-	-----	TxA-	-----	TxA-
COMA	-----	COMA	-----	COMA

10.4.2 Hardware Setup

All nodes must be set for 2 wire operation by setting the following jumpers and switches

Jumper J5	Position B
S1-1	On
S1-2	On

In addition pull apart resistors must be used on the highway. It is recommended that 2, 3 or 4 nodes on the highway have these resistors fitted. If more nodes include these resistors there is a danger of overloading the highway, resulting in adverse operation. Pull apart resistors are connected by the following setting:

S2-1	On
S2-2	On
S2-3	On
S2-4	On

10.4.3 Software Setup

All peer nodes on the highway must have different Peer Node numbers.

All peer nodes on the highway must have Port 1 set to Peer to Peer use, and be set for the same data communication speed.

10.5 Setting Up Port 1 and 2 for RS232 or RS485 Communications

Ports 1 and 2 have the ability to be set for 2 wire RS485, 4 wire RS485 or RS232 communication. The jumpers and switches on the main board make the settings.

10.5.1 RS485 or RS232 Selection

Port 1	LK6	J5	J6 (RTS)	J10 (CTS)
RS232	yes	A	A	A
RS485	no	B	no	no

Port 2	LK7	J8	J9 (RTS)	J7 (CTS)
RS232	yes	A	A	A
RS485	no	B	no	no

Port 1	S1-1	S1-2	S1-3	S1-4
RS232	Open	Open	X	X
RS485 - 4 wire	Open	Open	X	X
RS485 - 2 wire	Shut	Shut	X	X

Port 2	S1-1	S1-2	S1-3	S1-4
RS232	X	X	Open	Open
RS485 - 4 wire	X	X	Open	Open
RS485 - 2 wire	X	X	Shut	Shut

10.5.2 RS485 Line Termination

The RS485 highway will benefit from having correct line termination resistors. In the Pakscan IIS master station the termination uses biasing resistors instead of simple end of line connections. Biasing resistors should be fitted to every network as they ensure correct line states are maintained when the line is idle. No more than 3 devices on any highway should have the biasing resistors selected so as not to overload the line itself.

Port 1	S2-1	S2-2	S2-3	S2-4	Port 2	S3-1	S3-2	S3-3	S3-4
RS232	Open	Open	Open	Open	RS232	X	X	Open	Open
Terminate RS485 - 4 wire	Shut	Shut	Open	Open	Terminate RS485 - 4 wire	X	X	Open	Open
Terminate RS485 - 2 wire	Shut	Shut	Shut	Shut	Terminate RS485 - 2 wire	X	X	Shut	Shut

10.5.3 Connecting to Port 1 and 2

The connections for these two ports are made on the terminal strip at the bottom of the main pcb.

4 wire RS485

Make sure the links and switches are correctly set for RS485, 4 wire

Port 1	Terminal	Port 2	Terminal
TxA+	----- 1	TxB+	----- 9
TxA-	----- 2	TxB-	----- 10
RxA+	----- 3	RxB+	----- 11
RxA-	----- 4	RxB-	----- 12
COMA	----- 7	COMB	----- 15

2 wire RS485

Make sure the links and switches are correctly set for RS485, 2 wire

Port 1	Terminal	Port 2	Terminal
TxA+	----- 1	TxB+	----- 9
TxA-	----- 2	TxB-	----- 10
COMA	----- 7	COMB	----- 15

❑ **RS232 (without Modem control)**

Make sure the links and switches are correctly set for RS232

Port 1	Terminal	Port 2	Terminal
TxA-	----- 2	TxB-	----- 10
RxA-	----- 4	RxB-	----- 12
COMA	----- 7	COMB	----- 15

10.6 Connecting to Port 3 for RS232

Port 3 is fixed for RS232, non-isolated, serial communications. There are no Modem controls on this port.

Port 3	Terminal
TxC	----- 24
RxC	----- 25
COMC	----- 26

10.7 Diagnostic Information

The master station can provide information via its own display that can help in commissioning and fault finding.

10.7.1 Loop Configuration

The loop should configure with no loopbacks. If loopbacks are in use (as indicated by the master station status display), the loop diagnostic screen will indicate which field units have loopbacks asserted. The line fault will be at or between these units.

A code indicates the reason why loop configuration was last done. This can be useful if the system repeatedly carries out loop configuration, or fails to configure correctly.

The Port A and Port B LED's may help in indicating what is happening. At start-up or after a "Reset Loop" command the master station waits until it is sure that all the field units are in loopback. This time is about 10 seconds at 1200 baud. The Port A LED will come on when there is a complete current circuit. If it does not come on, there is a break near the Port A end.

The Port A LED then flickers as field units are found and their loopbacks removed. If the loop circuit is complete, normal scanning will then start as indicated by both LED's flickering together. The master station status will be reported as "Loopbacks Off".

If the loop continuity is incomplete, the master station switches to Port B after it has found all the field units connected to Port A. The Port B LED then flickers as field units are found there. Having found all the field units, the loop has to be left with loopbacks on the last-on-circuit field units only. This involves waiting for loopbacks to come on again, and then removing all of the loopbacks up to the field unit before the loop fault. The Port A then Port B LED's flicker during this stage. Normal scanning of a broken loop shows up as both LED's flickering, but not together.

Should the setting of field unit parameters have been carried out incorrectly then the system will identify a field unit that has an address too high or duplicated with another and eliminate these from the routine data polling. They are marked in the data base as in error and their individual data screen displays show Comms Failure and Field Unit Fault.

10.7.2 Loop Communications

On a well-behaved loop, the error rate in communications with each field unit should be very low. The system should be Reconfigured, and once running successfully with no loopbacks present examine the FCU Map and Failure Counts screen (as shown in section 8.5.5).

This screen allows verification that the loop wiring follows the desired pattern. The screen shows both the physical position on the loop and the address of each field unit that is in communication with the master station. The screen also reveals a counter recording the number of failures in communications with each field unit. This counter records every error, including those that do not result in a communication failure alarm. (The alarm is only generated if the communication fails 3 times in succession), and it may be set to zero by the 'Clear' button.

In most systems communication errors will occur due to interference from associated plant. The main thing is that they should be relatively infrequent. Examining the counter, waiting a short while, and comparing the new value with the original is used to monitor the system performance. The counter only refreshes when the screen is first loaded, so to see changes it is necessary to leave and return to the selected screen. There should not be a significant change in the error count. If there is a large difference then it is an indication that there is a problem on the loop. This may be a cable fault (low resistance to earth for example), or that the loop is being run too fast for the cable fitted, or that a particular field unit is not functioning correctly.

If line errors cause problems the most likely causes are:

- (1) Twisted pair screen not earthed at master station
- (2) Twisted pair screen earthed at both ends
- (3) Twisted pair screen broken/not linked at field unit(s)
- (4) Line resistance too great
- (5) Line capacitance too great
- (6) Incorrectly adjusted loop voltages

10.7.3 Loop speed reprogramming

Problems can occasionally arise during loop speed reprogramming resulting in the loop being left with field units set at different speeds.

It is possible to recover from this situation by the following procedure:

- (1) Set the desired loop speed to that of the field units which the master station CANNOT talk to.
- (2) Re-configure the loop
- (3) Re-configure the loop again.

The master station should now be in communication with ALL the field units. Repeat the whole procedure if not. In some cases individual field units may need to be reprogrammed with a Paktester or IQ Setting Tool.

10.7.4 Checking Host Communications

If there are no communications between host and master station, check the diagnostic screen's 'Rx' and 'Tx' flags. Check the port setups at each end (baud rate, parity, etc.), and the cable connections between the two. These checks will usually succeed in getting messages going to and fro.

To assist in verifying that host communications are functioning correctly a simple screen is available that shows Modbus messages that have been received, and the validity of the messages. The 'Port Diagnostic Display' is available for Port 1, 2, and 3 (see section 8.5.2). The last Modbus message received is displayed and the number of messages together with an error count. Pressing the 'Load' button will update the screen to the latest information. Successive screen interrogations will reveal all the Modbus messages being sent to the master station. Pressing the 'Clear' button will reset the message counter to zero.

10.8 Final Checks

When the system is operating correctly use the following list to verify that everything has been covered.

Action	Done
a) Communication with every field unit and its operation has been verified
b) All jumper links on the master station are correct and the station Address set
c) The loop parameters for highest address, baud rate and doubling are set
d) Port 1, 2 and 3 communications have been set, ESD actions have been set
e) The Security PIN and Access level has been set, tag names are entered
f) The Comms Fail count for each field unit has been set to zero
g) The Port 1, 2 and 3 Exception Message count has been set to zero
h) The Clock has been set to the correct time and date
i) All the covers are replaced
j) The documentation record is complete

10.9 Commissioning Aids

Two handheld devices are available to aid commissioning and fault finding. The first is the Paktester, (Field Test Unit), that may be used to interrogate and control a single field unit via the 2 wire interface. This requires the disconnection of the field unit from a live loop. The Field Test Unit can also program various field unit parameters.

The second device is the Master Station Test Unit (or Pakreader) which communicates with a master station via the host serial links. Modbus discrete bits and registers may be read from and written to, allowing a master station and field units to be monitored and controlled.



Fig 14: Paktester



Fig 15: Pakreader

(This page is intentionally blank)

11 MASTER STATION SOFTWARE VERSION

The software version and type of the master station is displayed on the Top Diagnostic Display (8.5.1) A record should be made of this data, together with the serial number of the system, for future reference.

The serial number will be found on a data label inside the door of the unit.

The master station type includes a code as follows:

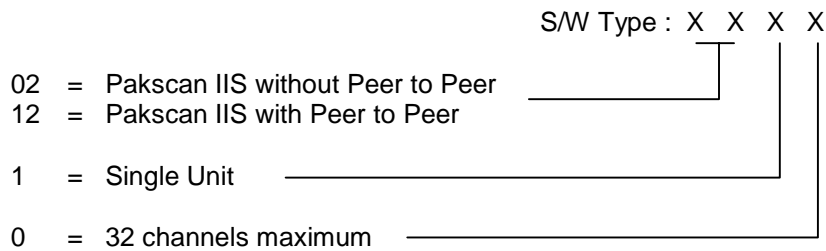

The version code is V: X.X, where digits following the V are the version number.

Both the V25 CPU and the Loop Driver processors have their own software. The version of software for these two processors must be compatible.

(This page is intentionally blank)

12 SET UP DATA RECORDS

A copy of the following is a table should be completed for every master station in your system. Keep the record safe so that in the unlikely event of a failure you can quickly restore the settings when replacing the unit.

Master Station Setup Record:			
Master Station	Modbus Address	Host	=
		Seq	=
		Peer Number	=
Protocol	Selected on Port 1		= RS232 / RS485
		Baud Rate	=
		Parity	=
Protocol	Selected on Port 2		= RS232 / RS485
		Baud Rate	=
		Parity	=
Protocol	Selected on Port 3		= RS232
		Baud Rate	=
		Parity	=
Alarms			= Linked / Separate
Security		PIN	=
		Access Level	=
Loop		Baud Rate	=
		Highest FCU address	=
		Doubling	= On / Off
ESD		Serial Input	= Enabled / Disabled
		Keypad	= Enabled / Disabled
		Input terminal	= Enabled / Disabled
Tag Names		set	= Yes / No
Clock		set	= Yes / No
Software version		Main	=
		Loop	=
		Serial Number	=
		Supply Voltage	=

12.1 Loop Map

Complete the following chart showing the position and address and type of each field unit

Position	Address	Type
1		
2		
3		
4		
5		
6		
7		
8		
9		
10		
11		
12		
13		
14		
15		
16		

Position	Address	Type
17		
18		
19		
20		
21		
22		
23		
24		
25		
26		
27		
28		
29		
30		
31		
32		

For each field unit you should record the settings made for the performance of the field unit.

Field units are of 3 basic types, IQ Actuator, Actuator and General Purpose. The settings you should make are detailed in the Paktester manual and the following charts used to note the settings for future reference. Alternately the records can be made automatically by connecting the Pakloader PC utility to the master station after commissioning the loop and saving the file created.

IQ Actuator Field Units

Actuator Type	Tag
Address	Baud Rate
Analogue Update Time	Analogue deviation Threshold
Motion Inhibit Time	Motion Inhibit Deadband
Torque Update Time	Torque Update Deviation
Torque Filter	Valve Travel Time
Auxiliary Mask (7)	(0)

Actuator Field Units (Integral)

Actuator Type	Tag
FCU Type	
Address	Baud Rate
Analogue Update Time	Analogue deviation Threshold
Motion Inhibit Time	Motion Inhibit Deadband

General Purpose Field Units (Actuator Mode)

Actuator Type	Tag
FCU Type	Mode Actuator
Address	Baud Rate
Analogue Update Time	Analogue deviation Threshold
Motion Inhibit Time	Motion Inhibit Deadband

General Purpose Field Units (General Purpose Mode)

Tag	Actuator Man'fer/Type
FCU Type	Mode GP
Address	Baud Rate
Relay O/P mode	
An I/P 1 Deadband	An I/P 2 Deadband
An Report Timeout	
Digital Input Sense (8)	(1)

(This page is intentionally blank)

13 TECHNICAL SPECIFICATIONS

13.1 Master Station

Enclosure	Weather-proof to IP65
Cable Entry	4 x 20 mm cable entry holes
I/O Connections	Screw clamp terminals suitable for 1.5 ² mm cables
Power Connection	Screw clamp terminals suitable for 1.5 ² mm cables
Supply Voltage	90 to 264V ac, 43 to 440Hz, Fuse 1 Amp
Power Consumption	30VA
Environmental Spec	Operating Temperature -10 to 60°C Storage Temperature -10 to +70° C Humidity 5% to 95% RH non-condensing
Serial Communications Ports (all ports)	
Protocol	Modbus RTU
Format	Asynchronous
Baud rate	1200, 2400, 4800, 9600, 19200 and 38,400 (not port 3)
Parity	Odd, Even, or None
Stop Bits	1
Port 1 and 2	Both RS485 (isolated) or RS232
Port 3	RS232
Relay Contacts outputs	300 mA at 24V dc or 130 mA at 125V ac

13.2 Actuator Field Units

For data on field units fitted inside Rotork actuators refer to the actuator or field unit data sheets. The integral field units operate in the same environment as the actuator, using the actuator power supply and communicating commands and data directly with the actuator electronics.

13.3 GP Field Unit

Environmental Spec	Operating Temperature -30 to +70°C Storage Temperature -40 to +85°C
Power Supply	110V ac +/-20%, 240V ac +/-10%, 50/60Hz +/- 1Hz
Output Relays	2A, 130V, 60W, 125VA (exclusive maxima)

13.4 2-Wire Loop

Maximum d.c. resistance	500 ohm
Maximum capacitance	4.43 μ F (at 110 baud) excluding field units
Maximum applied voltage	15V

Cables

The recommended cables to use for the loop wiring should be a twisted pair with an overall screen. The construction will usually be copper conductors and pvc insulation. There may be additional outer protection in the form of armour. This type of cable has a reasonably constant performance characteristic and the following is typical of the cable parameter data found from suppliers such as Beldon.

Cross Section (mm ²)	Resistance Ω /km @ 20 °C	Capacitance pF/m
0.5 solid	36.8 Ω /km	115 pF/m
0.5 flexible	39.7 Ω /km	115 pF/m
1.0 solid	18.4 Ω /km	115 pF/m
1.5 stranded	12.3 Ω /km	115 pF/m

Maximum Loop Distances

The cable resistance and capacitance must not exceed the permitted maximum values for each communication speed. The limiting values of C and R for each speed will depend on the number of field units actually connected. The following table gives the figures for systems with up to 32 field units connected.

Baud Rate	R max (ohms)	C max for 32 FCU systems (μ F) ^①
110	500	4.43
300	500	2.03
600	500	1.47
1200	500	0.53
2400	500	0.23

① Each field unit will add a capacitance of 2.2nF
The C max figure given is the maximum value for the cable capacitance without including any field unit capacitance.

From the cable data and the figures for the maximum permissible resistance and capacitance at each baud rate the maximum cable distances can be calculated for each baud rate. Note that the loop distance is the length of the twisted pair cable.

Loop Distance (km) - Number of FCU = 32			
Baud Rate	with 1.5mm ² cable	with 1.0mm ² cable	with 0.5mm ² cable
110	20.3 km	13.5 km	6.3 km
300	17.6 km	13.5 km	6.3 km
600	12.7 km	12.7 km	6.3 km
1200	4.6 km	4.6 km	4.6 km
2400	1.9 km	1.9 km	1.9 km

Scanning Time

The time to scan the loop, in seconds, for various baud rates, set up on the master station, with 32 FCU's, (doubling in action) is shown in the table. The times assume that only one field unit has data to report during the scan.

Scan Time (seconds)	
Baud Rate	Number of FCU = 32
110	4.5 sec
300	1.6 sec
600	0.8 sec
1200	0.4 sec
2400	0.2 sec

Command Time

The time taken for each command, from when the master station sends the command to when the field unit receives it is shown in the table (doubling in action). Commands are interleaved between poll messages, so a command is actioned almost immediately.

Command Time (seconds)	
Baud Rate	Time (msec)
110	432 msec
300	216 msec
600	108 msec
1200	54 msec
2400	27 msec

The time for the feedback response to the command, e.g. change in digital status resulting from a motor starting, is:

$$\begin{array}{ll} 1/2 \text{ loop scan time} & \text{(typical)} \\ \text{loop scan time} & \text{(worst case)} \end{array}$$

Commands are sent individually to each actuator. Multiple commands require multiple messages.

13.5 Peer Highway Cycle Time

The time taken to complete a cycle of polling all peers on the peer-to-peer highway depends on the peer highway speed, the number of attached peers, the quantity of data that peers have to broadcast, and the loading on the master station due to other communications and sequences. Some estimates of times (in seconds) are given in the following table for a selection of peer configurations:

Number of Peers	19k2 Baud		38k4 Baud	
	4 regs/peer	100 regs/peer	4 regs/peer	100 regs/peer
4	0.47	0.99	0.40	0.65
8	0.62	1.66	0.47	0.99
16	0.94	3.02	0.62	1.66
32	1.56	5.72	0.94	3.02

These figures give an indication of how fast peer will be transmitted from one peer to others in a given system.

13.6 External Connections

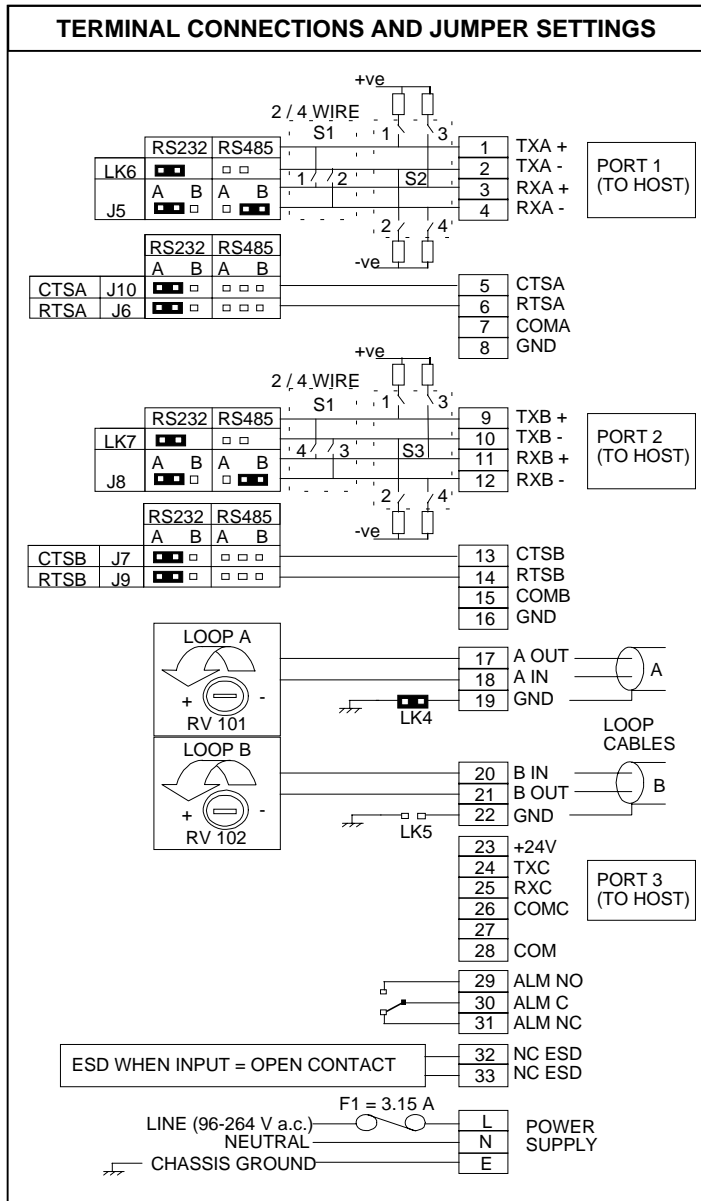

Fig 16: Terminal Connections

The single row of terminals towards the bottom of the enclosure are used for all the input and output connections to the 2 wire loop and the host system comms.

Fig 16: shows the connections, together with the jumpers and switches that affect the use of some of the connections.

Terminals 1 to 8 - Comms Port 1 (A) and Terminals 9 to 16 - Comms Port 2 (B)

The comms ports are configurable for RS232 or RS485 (2 or 4 wire). In RS232 mode modem control signals are available. In RS485 mode there are no modem control signals available and switches S1-S3 are used to select 2 or 4 wire and if this part of the data highway is to have termination resistors connected. Correct line termination of the RS485 highway is essential if the communications is to be sound. Only Port 1 can be used for Peer to Peer communication.

In 2 wire RS485 mode the connections are made to Tx+ and Tx-.

Terminals 17 to 22

The 2 wire loop is terminated on these terminals. The order of connection is important if the features of the system are to be realised. It is also necessary to correctly terminate the cable screens so as to prevent unwanted RFI emissions from the loop cable.

Terminals 24 to 26

Port 3 is connected to these terminals. Port 3 is a fixed RS232 port.

Terminals 29 to 31

The system alarm, generated if there is any alarm on the system at all, is brought to these terminals. The contacts C and NO are open when the system is healthy and has power applied. The contact C and NO close if power is lost or there is an alarm present.

Terminals 32 and 33

The system ESD contact, when used, is wired across these terminals.

The ESD (Emergency Shut Down) signal may be configured as described in section 8.6.7.

Note that each actuator is individually set for the action required on receipt of an ESD signal over the 2 wire loop.

Terminals LNE

The input power supply (90 to 264V a.c.) is connected to these terminals.

13.7 Master Station Dimensions

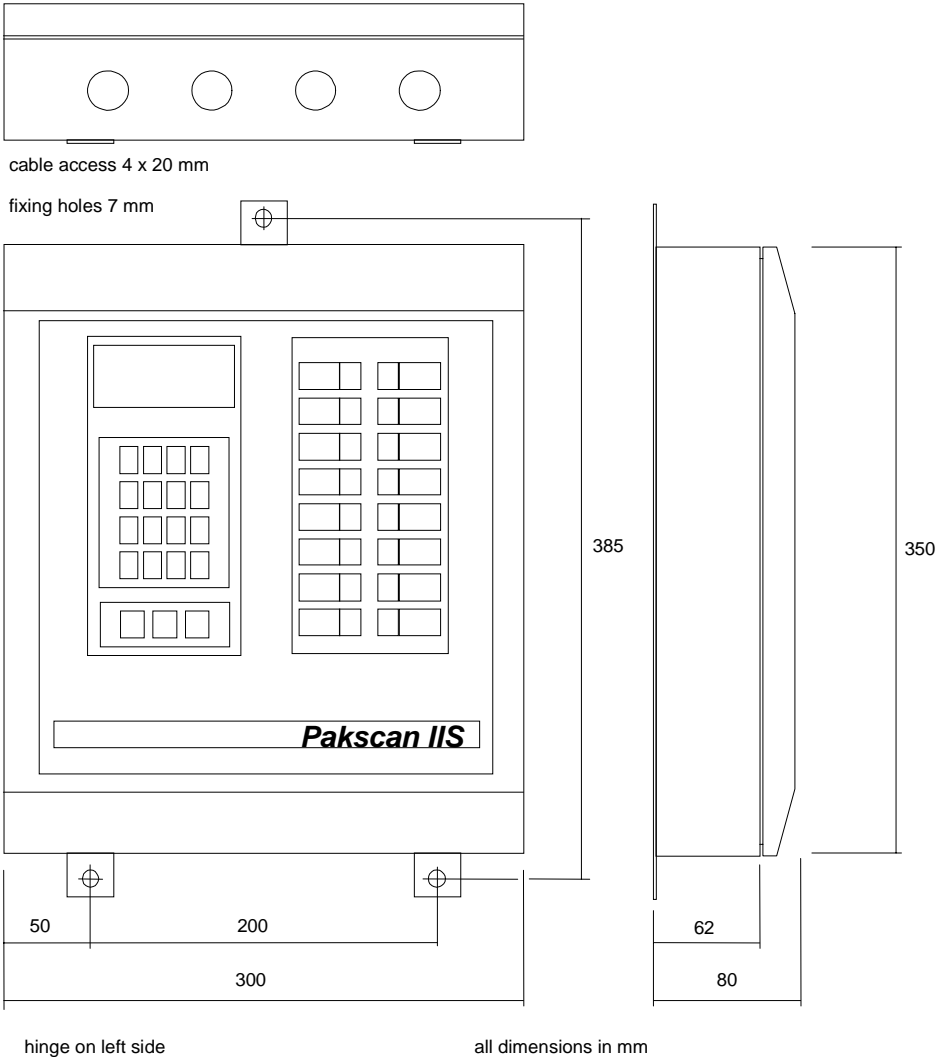

Master Station Weight:	5.5 Kg
Material:	Steel cabinet
Weatherproof Rating:	IP65

Fig 17: Dimension Details

13.8 Pushbutton and LED Label Inserts

The Function buttons F1 to F8 and LED 1 to 8 can be individually labelled by inserting a simple paper label behind the front panel membrane. The labels are inserted in the slots inside the front door.

The full size diagram shows the size of the labels and the position in which any text should be located. They may be produced on a suitable printer using a word processor and can be in colour if required. Make sure the text fits within the label free area and the clear panel on the master station front. Once printed, simply cut out the label and carefully slide it in the slot.

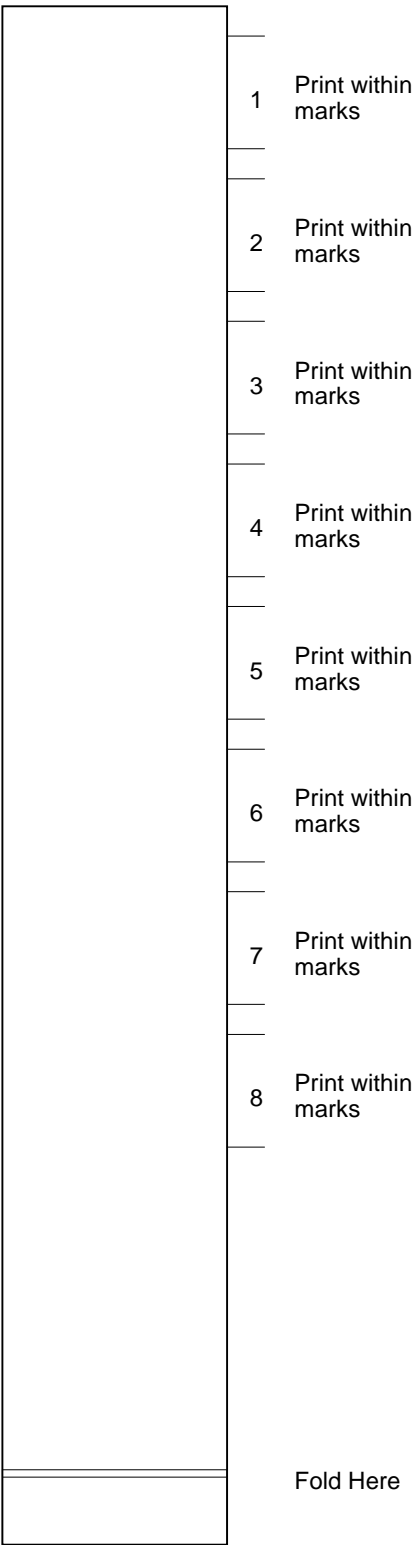

Fig 18: Door Label

Material: 100-120 GSM paper

13.9 Communication Port Typical Connections

The following information may help in setting up the communication link between a host computer and the master station. It is not practical to cover every eventuality and sometimes some experimentation may be necessary. All the examples refer to Port 1 (A), Port 2 (2) and Port 3 (C) are similar.

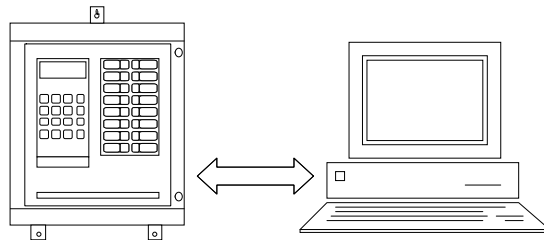

Fig 19: RS232 connections

RS232 Link without Modem Control signals		
Master Station		RS232 Host
TxA- (2)	-----	9way D type pin 2
RxA- (4)	-----	9way D type pin 3
ComA (7)	-----	9way D type pin 5
Switches S1/1, S1/2 and S2 to be set OFF (Open)		

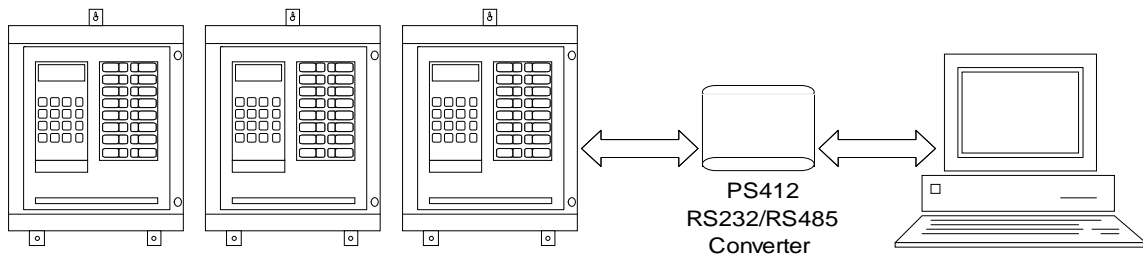

Fig 20: RS485 connections

RS422/RS485 Link to Rotork PS412 Converter (4 wire)		
Master Station		RS232 Host
TxA+ (1)	-----	9way D type pin 9
TxA- (2)	-----	9way D type pin 4
RxA+ (3)	-----	9way D type pin 8
RxA- (4)	-----	9way D type pin 3
ComA (7)	-----	9way D type pin 5
Switches S1/1 and S1/2 to be set OFF (Open)		

RS422/RS485 Link to Rotork PS412 Converter (2 wire)		
Master Station		RS232 Host
TxA+ (1)	-----	9way D type pin 8
TxA- (2)	-----	9way D type pin 3
ComA (7)	-----	9way D type pin 5
Switches S1/1 and S1/2 and S2 to be set ON (Closed)		

13.10 Sequencer Information

The Pakscan IIS master station includes a powerful sequence control function that permits the user to produce sequences for the automatic operation of the plant equipment. In addition every output can include an interlock function to prevent plant mis-operation.

The construction of sequences requires the use of a special programme that operates on a standard PC. This software, SCT, is described in its own manual.

To ensure correct communications when setting the SCT system to link to the master station the following should be chosen.

Protocol:	Generic Modbus
Baud rate:	9600 (equal to the PC's port)
Parity:	Odd

The following information defines the sequence and interlock capability.

Sequences:	80
Interlocks:	128
Sequence Control Blocks:	1000
Maximum number of blocks in one sequence:	100
Functions:	80
General Registers:	600
Sequence Flags:	1024
Timers:	128
PID loops:	16

Sequences 1 to 16 are executed in 0.25 sec, and all 80 sequences are executed in 1 second, so sequences number 1 to 16 are executed 4 times a second. The PID loops are all executed in 0.25 seconds and 4 times a second.

□ Data Base Locations:

The front panel LED's and Function buttons are accessed as DO and DI points in the master station data base when using them in a sequence. They are identified as follows:

Function Button	Identifier
F1	DI 00 01
F2	DI 00 02
F3	DI 00 03
F4	DI 00 04
F5	DI 00 05
F6	DI 00 06
F7	DI 00 07
F8	DI 00 08

LED	Identifier
L1	DO 00 01
L2	DO 00 02
L3	DO 00 03
L4	DO 00 04
L5	DO 00 05
L6	DO 00 06
L7	DO 00 07
L8	DO 00 08

13.11 Maintenance

The Pakscan IIS master station is not suitable for field repair. Should the unit require maintenance contact your local Rotork representative.

□ Battery Replacement

The master station contains a long life battery that should last for at least 3 years when no power is applied and considerably longer in normal use. Should the battery deteriorate a warning is displayed on the master station opening status screen. (The 'B' alarm may sometimes be generated on power on and can be cleared. This is normal for the unit.) The battery is used to retain the parameter settings, clock and sequence programmes in memory in the absence of mains power.

The battery is located in a holder on the main circuit board and it can be replaced by levering out the old battery and pressing in the replacement.

In the absence of both the battery and mains power an on board capacitor will maintain the memory data for at least one hour. In addition, basic setup data, such as port setups and addresses are held in non-volatile EEPROM.

14 GENERAL SAFETY INFORMATION

- ❑ **Customer information regarding installation, user safety, environmental and electromagnetic compatibility**
- ❑ **This information is provided to assist with conformance to the Health and Safety Act 1974 and various directives of the European Community.**

Mechanical

Care should be taken to avoid dropping heavy items - for example during installation or maintenance. Protective footwear should be worn when appropriate. Rotork products are not intended to carry the stresses involved in support of items supplied by others unless this has been specifically agreed to by the company.

Care should be taken to avoid contact with sharp edges or points, particularly if the product is partially dismantled.

Electrical

Products should be installed in accordance with BS6739.

Electrical supplies and earthing should be in accordance with BS7671

Care should be taken to ensure that voltages or currents in excess of those specified, or of reversed polarity, are not applied to the terminals of any products. If such excess is applied, the product should be returned to Rotork or otherwise checked by a competent person before re-use, even if no damage is immediately evident. Use only the specified fuse type and rating as replacements.

Products should not be operated with safety protective covers removed, or with safety interlocks overridden. Some products are designed to allow access by skilled persons whilst power is applied. The user must control such skill level and access and it should be remembered that electromagnetic compatibility may be compromised.

Galvanically isolated input or output signal circuits are provided by certain products. A competent person must decide upon any earthing arrangements for such circuits and users should regard them as carrying a dangerous voltage, unless they are earthed locally.

Batteries

Batteries must not be short circuited, or disposed of by burning. They must not be opened, punctured or crushed. Large batteries should only be used in well ventilated places. Their cases are generally ABS plastic resin and as such should be cleansed only with a damp cloth and not exposed to organic solvents.

Electromagnetic Compatibility

To ensure conformance to the EC Directive 89/336/EEC, installation should adopt the following cable arrangements:

All digital data cables and all analogue signal cables operating at or below 50 Volts should be shielded either by braid, armouring or metal conduit.

Such shields should be earthed as closely as possible to the product. If for the avoidance of ground loops it is not possible to earth these shields locally at low frequencies, they should nevertheless be so earthed via a capacitor effective at radio frequencies.

A single shield may be shared by any number of analogue signal cables.

Functional Reliability

Reliability predictions, (including failure mode and effect analysis), are calculated by Rotork using statistical methods and the resulting figures should only be used for statistical purposes. These predictions are only valid if the maintenance procedures and maintenance intervals stated in Rotork documentation are observed.

Environmental

Products should only be operated within the environment specified on the product data sheet. Take care not to obstruct ventilation paths.

In the event of ingress of any fluid or spray, products should be immediately switched off, and cleaned and dried by a competent person before re-use.

Chemical

Specific hazards will be the subject of product data. As a matter of good working practice, oral contact should be avoided.

Independently Certified Products

Such products must not be modified in any way by the user, and must be applied, operated and maintained in accordance with the relevant standards, certificates and reports.

Product Data Sheets

These should be checked for information that supplements or replaces that given above.

rotork

<http://www.rotork.com>

UK Head Office

Rotork Controls Ltd
Bath
England
BA1 3JQ

Tel: +44 (0) 1225 733 200
Fax: +44 (0) 1225 333 467
e-mail: mail@rotork.co.uk

USA Head Office

Rotork Controls Inc
675 Mile Crossing Blvd
Rochester
New York 14624
USA

Tel: +1 716 328 1550
Fax: +1 716 328 5848
e-mail: info@rotork.com