

The logo for rotork, featuring the word "rotork" in a bold, red, sans-serif font with a registered trademark symbol (®) to the upper right.

Established Leaders
in Actuation Technology



Pakscan IIE

high integrity
master station

rotork®

Pakscan Two wire control system

Pakscan is the most successful system for the remote control of valve actuators using a two wire bus network in use today. It has been developed by Rotork to exactly match the market requirement for both long and short distance remote control of actuators and valves. The Pakscan system uses proven technology to meet the increasing demands of modern control systems and ensures high availability and reliability of the control system package

Pakscan sets the standard for two wire control and the Pakscan IIE master station provides the high integrity link from the DCS to the valves in the field.

The system combines three key elements – field units, the two wire loop cable and the master station itself. Together they provide unparalleled control, high availability and efficiency combined with extremely low maintenance costs.

By adding a completely independent standby Pakscan IIE master unit, the availability of the system in the event of a component failure is guaranteed. Multiple host ports allow for connection to two host systems at the same time, or dual redundant comms links where necessary. The field cabling is fault tolerant allowing the system to ride through any type of cable fault without losing actuator control. Further, if subsequent faults occur before the initial failure is repaired, the system will continue to operate as much of the plant as possible.

The field network can incorporate other devices into the Pakscan loop by using the General Purpose field units in one of their available enclosures.

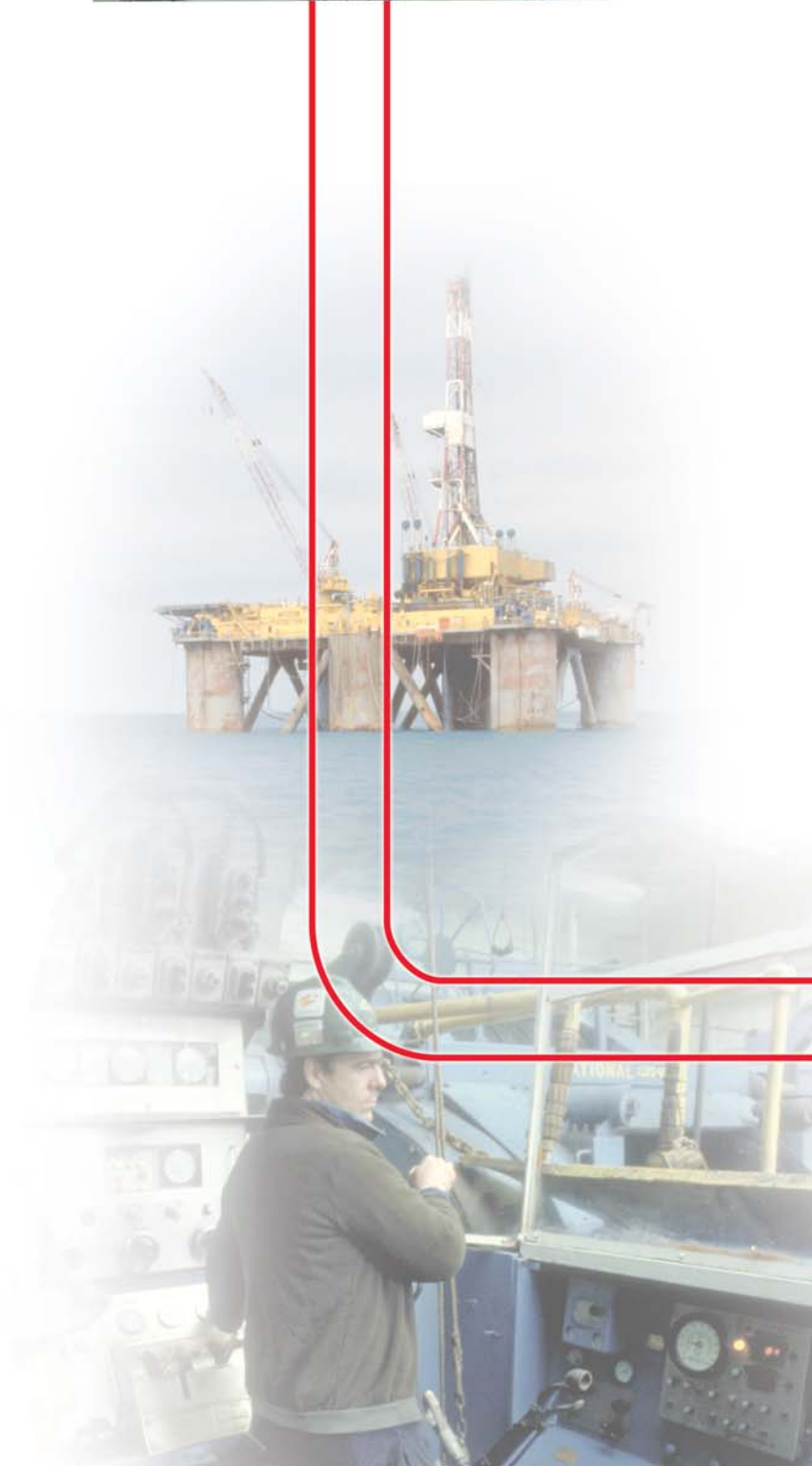

Installed Cost Savings

- Direct reduction in cable costs by using a single twisted pair instead of expensive multicore cable.
- Direct reduction in engineering costs due to network's simple design.
- Lower commissioning costs due to faster and easier installation.
- Increased plant productivity by reducing down time losses.

Low Cost of Ownership

- Increased information flow allows for optimised and correctly planned maintenance of the actuators and valves
- System fault tolerance ensures continuous operation even when a fault exists on the system
- In the unlikely event of a failure Pakscan is simple and quick to repair ensuring the shortest possible downtime
- Large number of inbuilt diagnostic features including communication performance data and fault location indication

High Performance

- Priority given to commands to the plant.
- Full monitoring and control of every field unit and actuator connected.
- Fully compatible with all Rotork actuators.
- Master station monitors the full network at all times, relieving the host system.
- Field unit parameterisation from the master station.

Simple Integration

- Industry standard Modbus protocol to PLC, DCS or In-Vision.
- Dual host communications capability.
- Multiple data base organisation for maximum efficiency.
- Proven communications to all major DCS and PLC suppliers.
- Master station supplied pre-configured.

Large Plant Capacity

- Each network has the capacity for up to 240 actuators distributed over a single 20 km 2 wire loop.
- No restrictions on inter-node distances.
- Capable of controlling various field devices including actuators, pumps, heaters and mixers.

High Reliability

- Field units integral with and double sealed inside Rotork actuators.
- High levels of surge protection for poor field environments.
- Non-intrusive setting of all parameters.
- Full isolation between the network cable and the field unit or master station.
- Secure communication protocol.
- Complete cable fault protection with redundant field communication path.
- Optional fully redundant master station.
- No repeaters necessary.

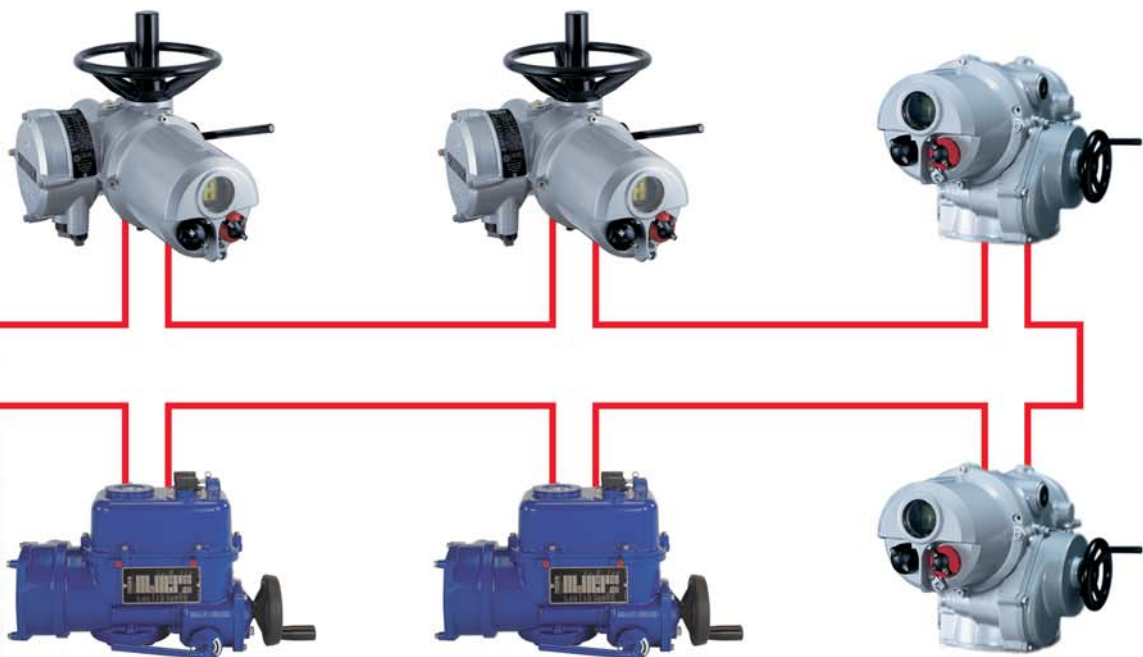

The System

Pakscan includes the experience gained by Rotork in network control systems and their application. The master station takes care of all the network communications. The systems engineer simply has to specify which slave address to use for each actuator and determine the cable route and length.

Continuous Monitoring	Pakscan continuously monitors the plant status and makes the status available to the DCS.
Two wire loop	Up to 240 field units distributed over a 20 km twisted pair loop.
Compatibility	Fully compatible with all current Rotork electric actuators and In-Vision HMI products.
High Integrity	Hot standby master station. Second unit takes control in the event of a fault on the main unit.
High Reliability	Dual power supplies and fully redundant hardware for maximum reliability.
Dual Host Comms	RS485 and RS232 host communications options using Modbus protocol.
Loop Fault Tolerant	Short, open or ground faults on the loop do not prevent continuing operation.
Comprehensive Indication	All faults are announced to the host system. Display panel shows conditions.

Applications

Since its inception Pakscan has found acceptance in all industry sectors and many diverse applications. Wherever Rotork actuators are to be found there will be a Pakscan system to operate them.

- Oil and Gas Storage
- Tank Farms
- Refinery plant
- Water Filtration plant
- Potable Water Treatment and Storage
- Waste Water Treatment plant
- Flood control
- Off shore platforms
- Gas production wells
- Power station boilers and turbines
- Metering skids
- Tunnels and Pipelines



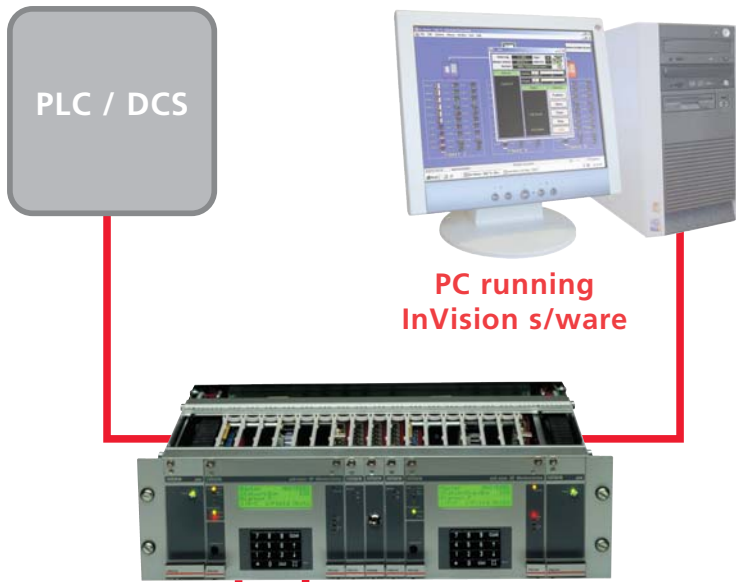

Control and Data Available from a Pakscan IIE master station

Reset system (Reconfigure loop)
Change station to standby mode
Alarm accept
Loop condition register
Loop status
Main station status
Standby station status
Map of field unit locations
Cable fault type (open or short circuit)
Loop data rate
Configuration progress
Actuator alarm present
Field Control Unit alarm present

Cable Fault Protection

Field Unit Failure Protection

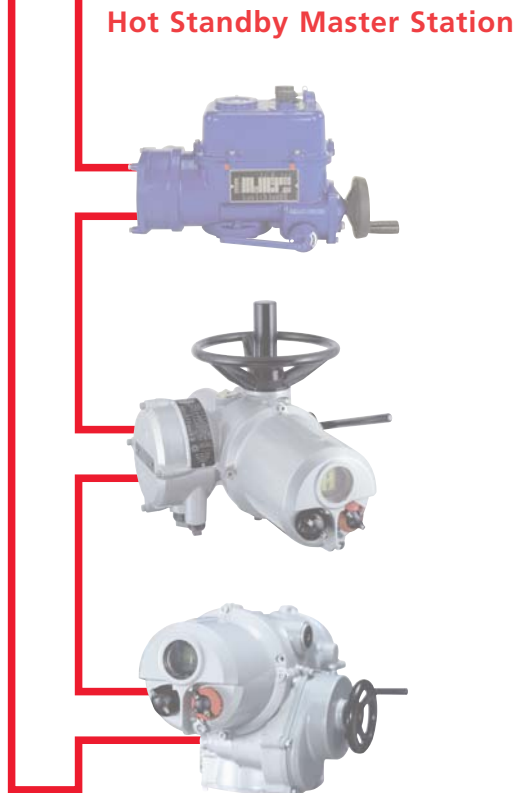

Data and Control for Field Control Unit Actuators

Open/Stop/Close/ESD digital control
Set Position 0-100% analogue control
Actuator current torque value 0-120% *
Valve position digital status (open/closed)
Valve position analogue status (0-100% position feedback)
Actuator Alarm status
Local/Remote selector position
Local Stop selected
Valve opening and closing digital status
Actuator torque tripped at end of travel
Actuator torque tripped in mid stroke
Battery condition low
Motor thermostat status
Valve manual movement
Contact failure to energise
Excessive valve travel time *
Motor still energised at end of travel
Communication failure
Field Control Unit failure
Torque profile in opening direction *
Torque profile in closing direction *

* = Rotork IQ Range actuators only



PAKSCAN IIE MASTER STATION

Each Pakscan IIE master station is self contained in its 19" rack housing. It comes complete with keypad and display screen to allow operators and engineers to see exactly what is happening with the system and the valve actuators at any time.

Simple Installation

The master station requires a power connection and the field cables to be attached and it is ready to go. Installation could not be simpler. In the case of a hot standby unit there is only a second power supply required. Host communications are added by simple plug in connectors and all connections are on the back of the rack.

Simple Configuration

Each system is supplied pre-configured, already having a full data base and Modbus protocol configuration installed when it is delivered. To complete the plant specific settings the number of field units, loop speed and host communication parameters are quickly entered using the integral keypad.

Simple Diagnostics

In-built diagnostics show the performance of the host communications, the individual field units and network cable. The screen and LED's show any alarms present on the system. The loop map shows the position of every field unit relative to the master station.

Field Unit Configuration

The master station also includes the ability to alter parameters in the field units from the master station itself. All the settings associated

with the Pakscan system such as analogue value reporting interval, motion inhibit time and so on can be amended from the field unit screens of the Pakscan IIE.

High Integrity Comms

Cable failure protection is automatically catered for by connecting the field units in a ring. Any field unit can be accessed either way round and when there is a fault in the cabling the unique loopback feature ensures that comms continues to be available.

Additionally all messages passed over the network are totally under the control of the master station as it contains the only current source. Each field unit is a slave and only sends information following a request and all messages are protected by framing and CRC checks.

Non-catastrophic failures due to noise on the system are handled on a repeat as necessary basis. A total of 3 failures to respond has to occur before the master station indicates comms failure to a field unit.

Where high reliability for the host communication is needed, the two Modbus communication ports may be set to operate in a high integrity mode. Simply connecting the comms ports on the main and standby master stations on a single RS485 highway allows the master station to seamlessly transfer control from one unit to the other without any loss of host communications.

The addition of PS410 converters to the master station RS232 ports also allows a dual RS485 highway to be set up to give high integrity host comms link.

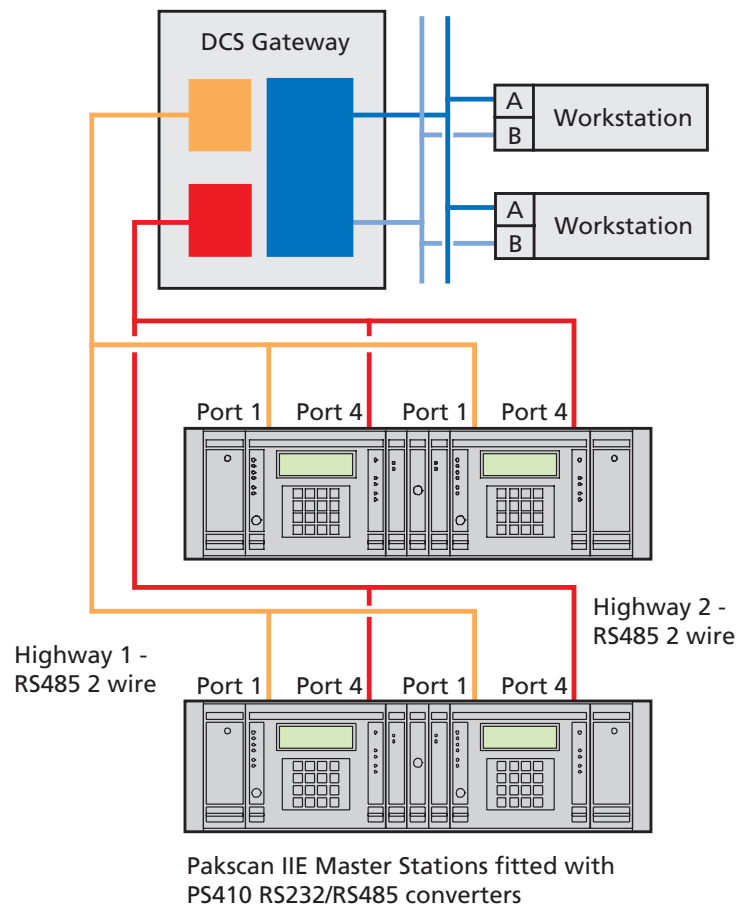

Diagram 3: High integrity communications from the master station to the DCS.

Automatic Change Over

The high integrity, hot standby version of the Pakscan IIE includes two identical modules in one rack. Either may be the main unit and automatic and transparent transfer between the main and standby unit occurs if there is a component failure in the main unit. In addition change-over can be initiated by the host system or from the keypad of the main unit. Should a fault occur within the standby unit this too is reported over the communication link to the host system.

Operator Password Protection

Some systems require protection against operation by unauthorised personnel. The Pakscan IIE master station includes a Personal Identification Number (PIN) protection method where, if required, the movement of valves or changes to the system settings can only be carried out from the keypad if the operator has first entered the correct PIN. Several levels of protection are available including one where control is permitted only if the host comms link is not operating.

Fault Annunciation

The LED's and screen are used to indicate any alarm condition that may arise from a field unit or within the master station. In addition the communication with the host system includes alarm indication data. If an actuator is switched off the master station will notice its absence and report the device failure to the host system. The alarm indication differentiates between system, master station, cable, actuator and field unit faults.

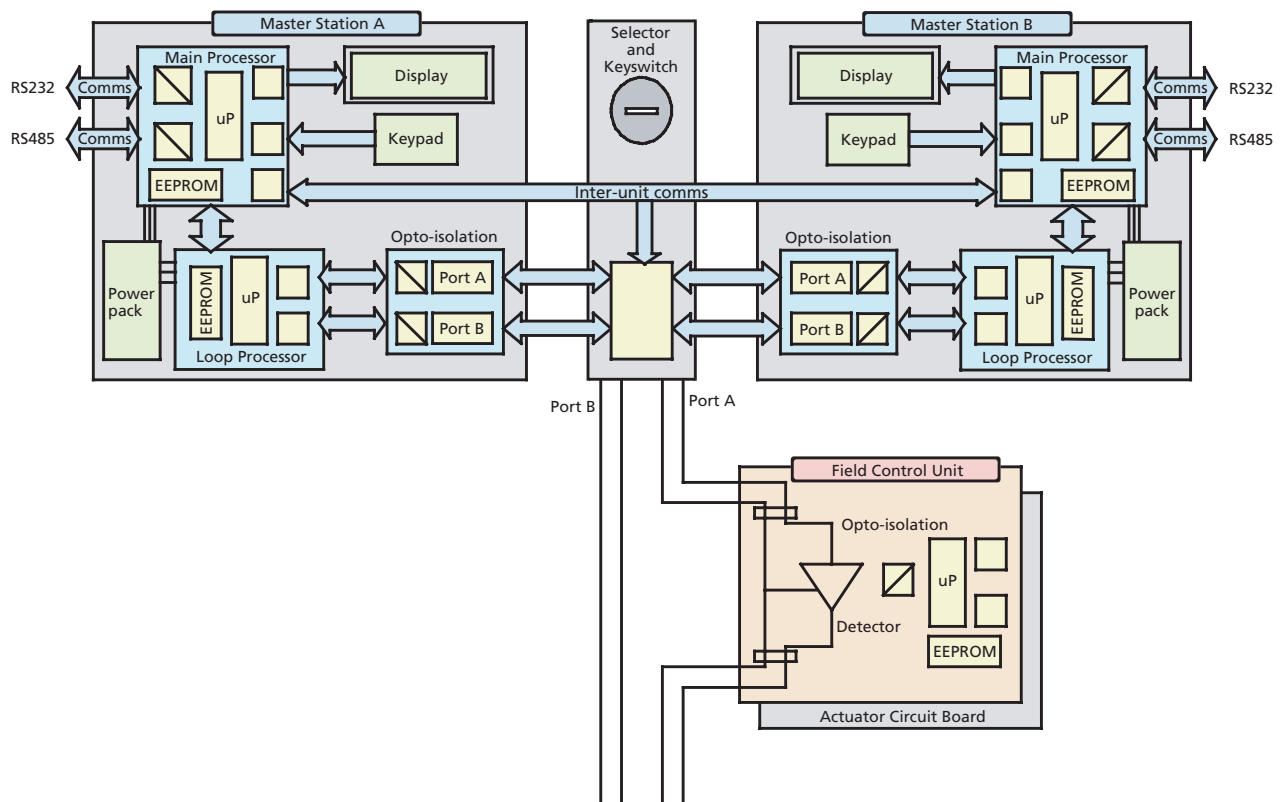

Diagram 4: Hot standby master station showing internal connections and isolation between system components.

Multiple Host Communication Ports

Each Pakscan IIE master station module includes two communication ports, one RS232 and one RS485. In addition there is space for a Pakscan PS412 converter to change either the RS232 port to RS485 or the RS485 port to RS232. The two communication ports can each communicate with a different host system or be used as a redundant communication highway. In a hot standby pair the most common configuration is to use two RS485 ports from the primary and the standby units in a multidrop configuration.

ETHERNET CONNECTIVITY

The optional Pakscan Ethernet bridge enables the IIE master station to link with the host system using a Local Area Network and Ethernet communications.

The bridge forms an integral part of the IIE master station fitting within the 19 inch rack assembly. It replaces one of the master station serial comms ports with an Ethernet port communicating using Modbus TCP.

The bridge makes the plant information available to the host system with minimal delay by holding current system data in its memory.

LAN Connection

The Pakscan Ethernet bridge operates an asynchronous communication link to the master station, polling it continuously for the latest data. The Ethernet connection is provided with this data ensuring no delay in responding to messages from the LAN.

Up to 10 simultaneous connections are allowed to the bridge and effectively several host systems can access data at the same time at speeds of 10Base-T or 100Base-TX.

The LAN can be extended to a wide area network or even to include a router onto the World Wide Web. Enabling the correct router port for Modbus TCP comms only increases the security of the system when used over the Internet. The user connection is a standard RJ45 Ethernet connector.

Modbus TCP

The Ethernet protocol used for data exchange and control is Modbus TCP. This widely used protocol allows for the data to be broken into packets for Ethernet transmission over the LAN.

Most host DCS and PLC systems, including In-Vision, support Modbus TCP and the embedded data follows either the standard Pakscan Generic, Honeywell or Yokogawa formats.

Modbus TCP is very similar to Modbus RTU with the same function codes used for communication control.

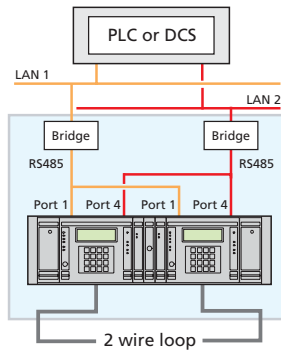

Embedded Web Server

The embedded web server allows the system performance, diagnostics and set up to be viewed at any time by connecting a PC to the Ethernet LAN and browsing to the bridge using standard Internet Browser software such as Internet Explorer. If the bridge is connected to the World Wide Web then the PC can be anywhere in the world, provided it has a web connection.

In addition to viewing the status of the plant, and when the correct passwords are entered, parameters can be altered and outputs changed allowing rapid corrective maintenance in the event of a field fault.

The server can even be configured to send e-mail messages to specified recipients should a system fault develop.

- System Configuration
- Alarm Monitoring
- Network Diagnostics
- E-mail notification

Security

The Modbus TCP communication protocol and the inherent protection of a router provide a high degree of security for the system. In addition the ability to alter the system or issue commands to the actuators is under password protection.

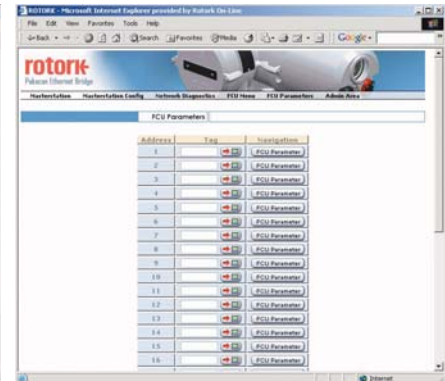
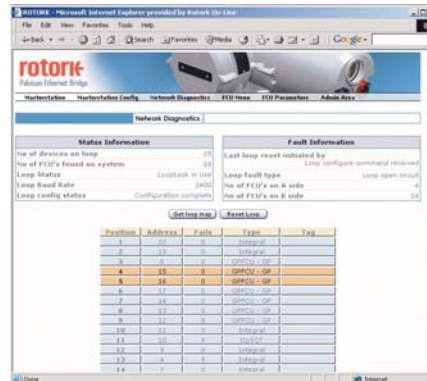
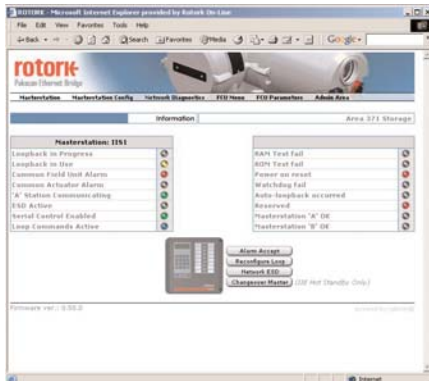
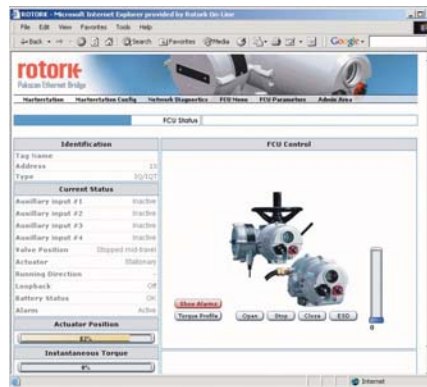

Loop Wiring

The Pakscan network carries a 15V 20 mA current loop signal. This signal is modulated by the master station to send and receive data from the attached field units.

The cable is a single twisted pair with an overall screen for protection which is easy to install, easy to maintain, low cost and highly effective in all operating conditions.

Comprehensive Data Reporting

2 wires carry the data previously requiring 22 conductors. No additional actuator hardware is needed for position or torque data reporting from IQ and IQT actuators.

Noise Protection

The Pakscan system protects against electrical interference by using a current loop and surge arresters. The use of a 20mA current loop automatically ensures that the system offers a low impedance to any noise currents and prevents

these currents from generating significant voltage spikes. Any voltage spikes that do result are swiftly clamped to acceptable levels by the high speed surge arresters fitted at each field unit and the master station.

System Fault Recovery

The two wires are connected to, and taken from, each field unit in turn. They originate from and return to the master station to create a single twisted pair two wire loop. As each device may now be accessed from either direction a redundant communication path is available. Pakscan fully utilises this arrangement in the event of a cable fault.

The integrity of the 2 wire cable is continuously checked whilst the system is running. In normal operation port A is acting as a transceiver and port B as a receiver only. The current passes from master station port A 'out' to port B 'in' via all the actuator field units. Port B is able to monitor all the communication from port A through the cable.

If the communications should fail for any reason, the master station stops transmission and after a quiet period all the field units assert their loopback circuits. A short period later the master station begins communicating to each field unit in turn from port A. It identifies each unit's address and instructs the field unit to remove its loopback. Progressively the current loop is extended until the location of the fault is revealed. Port B then reconfigures as a transceiver and the procedure is repeated from the other direction. Once the process is complete the system will have located the position and precise nature of the fault and maintained communication with all the field units on each side of the fault.

The loopback feature is unique to the Pakscan system and allows the system to have two communication routes without the need for two cable runs. It also allows the system to cope with cable breaks, short circuits and ground faults.

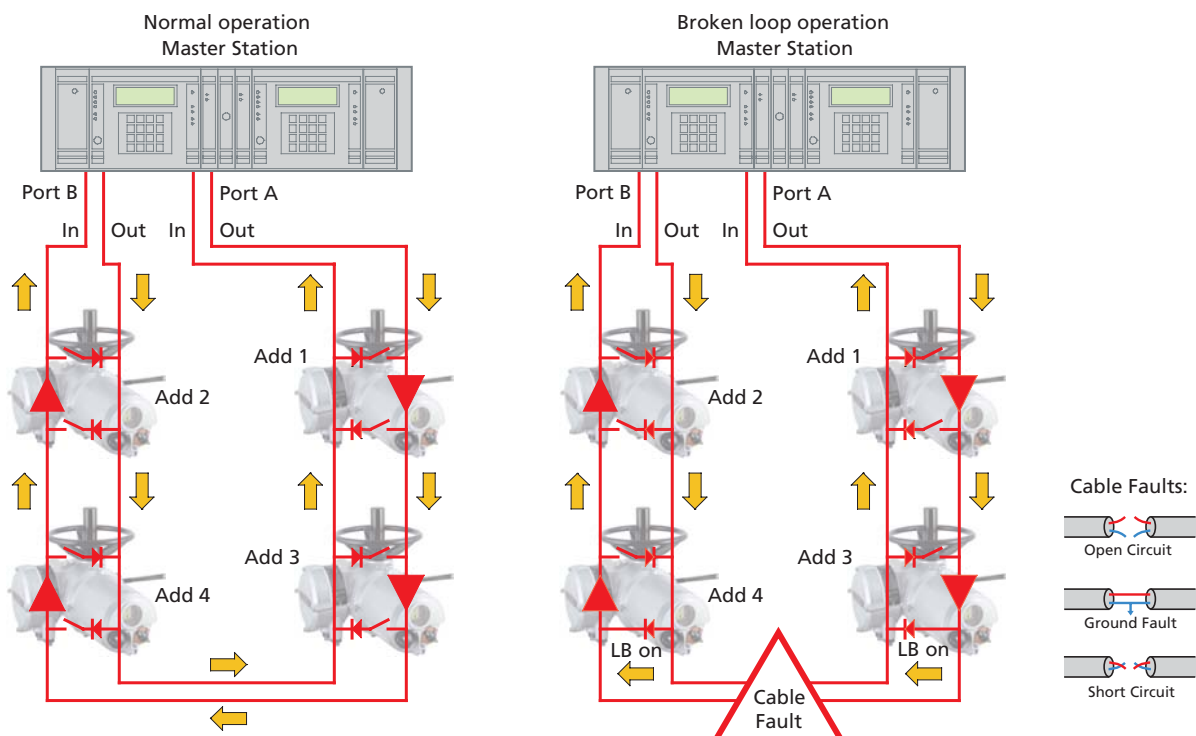

Diagram 2: System Fault Tolerance - 2 wire loop integrity.

HIGH PERFORMANCE

Pakscan networks use a unique proprietary protocol that achieves very fast update times whilst using relatively low data transmission rates. Compressing the data field to a minimum length allows more data to pass over the network in a given time at each data rate. The result is a system that can handle long transmission distances and a large number of units whilst still maintaining a quick and efficient communication.

Field units are scanned in turn by the master station and report their current status back in compressed code messages, shortening the transaction period to a minimum.

The field cable used for the Pakscan network is typical instrumentation cable. A simple twisted pair with overall screen using polyethylene insulation will suffice.

The use of low transmission speeds allows the current loop to achieve long distance communication with field devices without the need for repeaters. Where the loop distance is shorter then higher speeds can be used.

The communication protocol gives priority to instructions sent from the

master station to the field units. Commands are considered more important than reports so the routine polling of the field units is momentarily suspended when a command needs to be issued. Because command instructions occur infrequently there is a negligible effect on the the scan time for the system.

Scan Time (seconds)				
Baud Rate	Number of field units			
	60	120	180	240
110	8.4	19.3	31.1	42.9
300	3.1	7.1	11.4	15.8
600	1.6	3.6	5.7	7.9
1200	0.8	1.8	2.9	3.9
2400	0.4	0.9	N/A	N/A

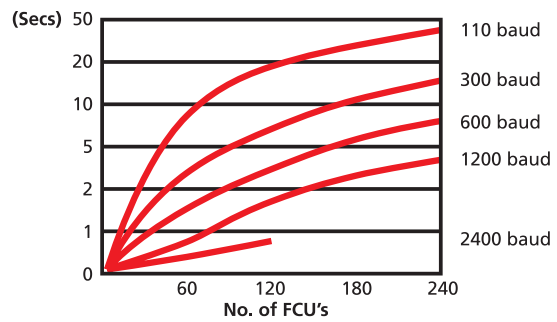

Loop Distance (km) with 1.5mm ² cable			
Baud Rate	Number of FCU		
	60	120	240
110	20.3	20.3	20.3
300	17.1	15.9	13.7
600	12.2	11.1	8.8
1200	4.1	2.9	0.6
2400	1.5	0.3	N/A

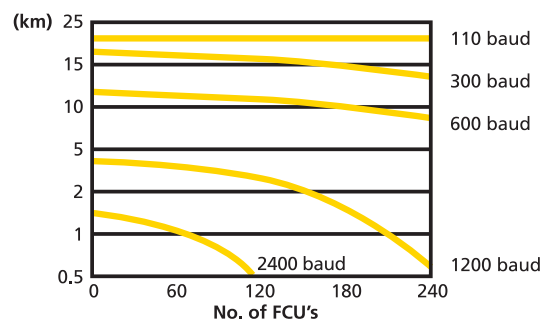

Time to issue a command (msec)	
Baud Rate	Time
110	614
300	230
600	110
1200	60
2400	30

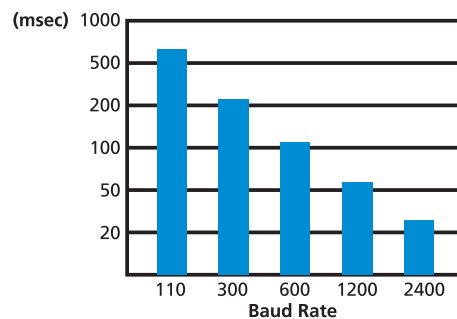

Options



Pakscan IIE

Control room or equipment room mounting, the IIE master station is capable of controlling up to 240 field units. Either one or two fully independent systems can be mounted in the 133 mm high 19" rack.

The Pakscan IIE is complete with two communication ports, a screen and keypad and the ability to include PS410 RS232/RS485 converters.



Pakscan IIE Hot Standby

The hot standby version of the IIE features two identical modules in one rack. Either may be the primary unit and transfer between the two is transparent and automatic on component failure.

Control room or equipment room mounting, this master station is capable of controlling up to 240 field units.



TSI - Touch Screen interface

Rotork's Touch Screen Interface is designed to be used with the Pakscan system. The HMI package installed can be a fully configured InVision or InVision MD, the maintenance and diagnostic version of the package.

Accessories

Paktester

Allows for setting the field unit parameters by connecting to the actuator directly.



Pakreader

Enables master station Modbus communications to be verified.



Converter PS410/PS412

Available as the PS412 free standing unit (supplied with a universal power pack) or as a PS410 card for insertion in the master station rack. The unit converts RS232 to RS485 and vice versa.

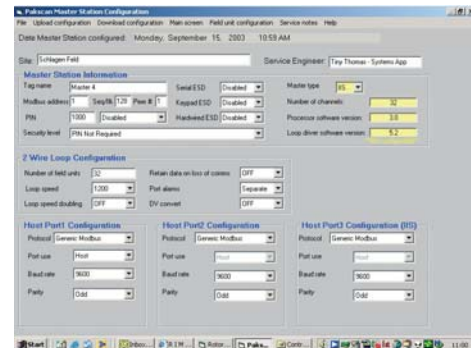

Mastertools

A software utility to allow full system diagnosis, configuration and report generation.

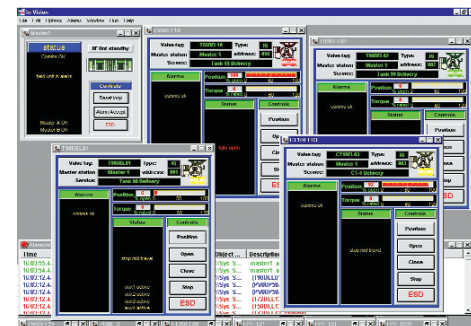

In-Vision

A complete HMI package for PC based control of the actuators on the loop.

TECHNICAL DATA

Enclosure	Standard 19" rack mounting to DIN 41494 with rear terminals and connectors.
Supply Voltage	a.c. 90 to 264v, 43-440 Hz Fuse 1 amp.
Power consumption	30 VA for each master station module. 60 VA for the Hot Standby master station.
Current loop	20 mA 15V max, Pakscan protocol.
Cable	Single twisted pair, 500 ohms max resistance, 3.9 uF max capacitance.
Field Units	240 maximum. Supports all Rotork actuator types IQ, IQM, IQT, Q, A, and AQ plus General Purpose field units.
Host Communications	Each module has 2 Modbus RTU half duplex comms ports, 1 off RS232, 1 off RS485 (2 wire) and space to add a PS410 RS232/RS485 converter. Each module optional Single Ethernet Modbus TCP instead of RS232 or RS485 connection, or dual Ethernet Modbus TCP replacing both RS232 and RS485.

I/O Connections	Screw clamp terminals and D-type connectors. Loop connection terminals and 25 way male connector. RS485/RS232 9 way male/female and female. Ethernet RJ45 connector. Supply connector IEC.
Environmental	Operating temp 0 to 50°C. Storage temp -10 to +70°C. Humidity 5% to 95% R.H. non-condensing.
Display	4 line by 20 character LCD 2 loop activity LED's 7 system status LED's The LCD contrast may diminish at extremes of working temperature range.
Controls	Numeric keypad, 16 keys.
Protection	Operations controlled by password protection.

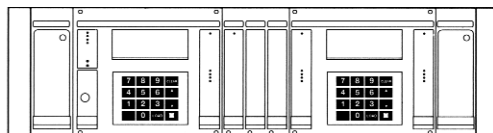

Front view

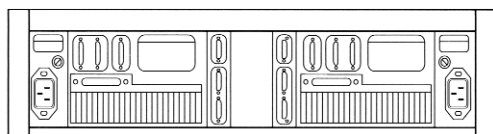

Rear view

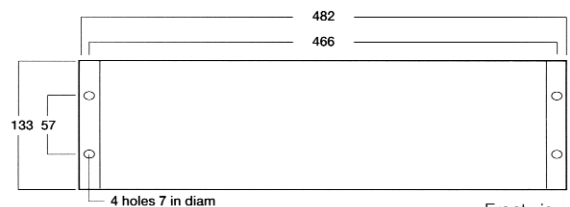

Front view

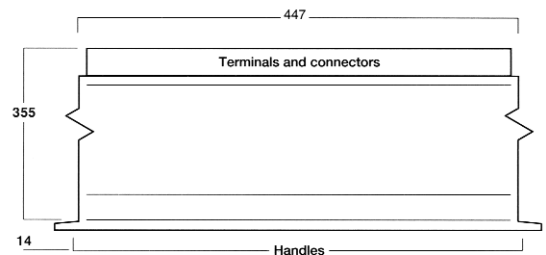

Plan view

All dimensions in mm



UK head office
Rotork Controls Limited
telephone Bath 01225 733200
telefax 01225 333467
email mail@rotork.co.uk

USA head office
Rotork Controls Inc
telephone Rochester (585) 328 1550
telefax (585) 328 5848
email info@rotork.com



Rotork Controls Ltd, Bath, UK



Rotork Controls Inc, Rochester, USA

A full listing of our worldwide sales and service network is available on our website at **www.rotork.com**

As part of a process of on-going product development, Rotork reserves the right to amend and change specifications without prior notice.

Published data may be subject to change.

For the very latest version release, visit our website at www.rotork.com

The name Rotork is a registered trademark. Rotork recognizes all registered trademarks. Published and produced in the UK by Rotork Controls Limited.