

**T7800 Series Transducers  
EMI/RFI Report to Standard  
EN61326 Meeting Requirements  
of EMC Directive  
2004/108/EC (replacing 89/336/EEC)**

## **Cover Page**

T7800 EMI/RFI List of Documents and Reports Meeting the requirements of EN61326 for bearing of the CE Mark.

### Enclosures:

1. ETL Certificate and Report - Verification TT7800-401 and TT7800-501 to EN50082-2 - Immunity
  - a. IEC1000-4-2, Electrostatic Discharge Susceptibility
  - b. ENV50140, Radiated Susceptibility – Electric Field Immunity
  - c. IEC1000-4-4, Electrical Fast Transient/Burst Susceptibility
  - d. IEC1000-4-6, Conducted RFI Susceptibility
  - e. IEC1000-4-8, Power Frequency Magnetic Field Susceptibility
2. ETL Certificate and Report - Verification TT7800-401 and TT7800-501 to EN55011 (CISPR 11:1991) - Emissions
3. Requirements (addendum) to meet EN61326-1:1998 + A1, A2, A3, Reaffirmed 2005
4. ETL Test results:
  - a. EN61000-4-3, Radiated Immunity (supersedes ENV50140 and IEC1000-4-3)
  - b. EN61326:1998 Table 3, Radiated Emissions
  - c. EN61000-4-5, Surges
5. EN61000-4-5, Surges – Self Declaration Test Data
6. Evaluation of EMC Directive 2004/108/EC replacing repealed Directive 89/336/EEC

Originator's Report Number: 551641

July 21, 1995

Test Report  
for  
Fairchild IPC, Inc.  
on the  
Model TT7800-401 and TT7800-501  
Electro-pneumatic Transducers

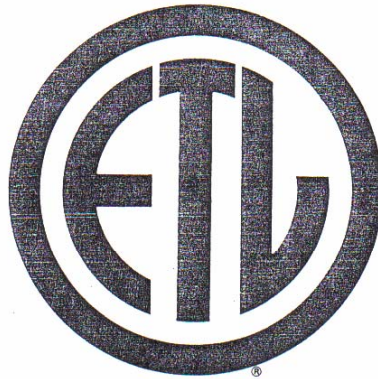

SINCE 1896

**ETL Testing Laboratories, Inc.**

---

*ETL is an independent testing and certification organization.*



**Inchcape Testing Services**  
**ETL Testing Laboratories**

ETL Testing Laboratories, Inc.  
4317-A Park Drive, N.W.  
Norcross, GA 30093  
Telephone (404) 925-2444  
Fax (404) 925-7294

Originator's Report Number: 551641

July 21, 1995

Test Report  
for  
Fairchild IPC, Inc.  
on the  
Model TT7800-401 and TT7800-501  
Electro-pneumatic Transducers

Test Performed by:

Inchcape Testing Services  
4317-A Park Dr., NW  
Norcross, GA 30093

Test Authorized by:

Fairchild IPC, Inc.  
3920 West Point Blvd.  
Winston-Salem, NC 27102

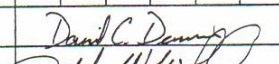
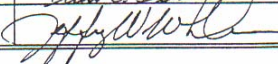
Test Initiated								May 25, 1995
Test Completed								July 21, 1995
Test Engineer								David C. Dennis
Team Leader								Jeffrey W. Whitmire

ETL TESTING LABORATORIES, INC.  
4317-A Park Drive, NW  
Norcross, GA 30093

## VERIFICATION

Fairchild IPC, Inc.  
3920 West Point Blvd.  
Winston Salem, NC 27102

August 7, 1995

## NOT TRANSFERABLE

Verification is hereby issued to the named GRANTEE and is VALID ONLY for the equipment identified hereon for use under the rules and regulations listed below.

Name of Grantee: Fairchild IPC, Inc.

Model or FCC Identifier: Model TT7800-401 and TT7800-501  
Electro-pneumatic Transducers

Applicable Regulation: 89/336/EEC  
EN50082-2

Note(s): (1) See attached Report dated July 21, 1995 for details and/or conditions of this Verification.

(2) Test methods employed conform to the Standard Operating Procedures of ETL Testing Laboratories, Inc.

Accredited by the National Institute of Standards and Technology  
for Emissions and Telecommunications Testing  
Approved by the Canadian Department of Communications for Telecom Testing

In correspondence concerning this Verification,  
please refer to the date, Grantee Name and Model No.

Inchcape Testing Services

---

Table of Contents

1.0	Introduction	1
1.1	Scope	1
1.2	Purpose	1
1.3	Summary	1
1.4	Testing Requirements	1
2.0	Test Environment	4
2.1	Test Sample Description	4
2.2	Test Facility	4
2.3	Test Equipment	4
3.0	IEC 1000-4-2, Electrostatic Discharge Susceptibility	7
3.0.1	Test Description	7
3.0.2	Test Procedure	7
3.0.3	Test Results	7
3.0.4	Test Configuration Photograph	7
3.1	ENV50140, Radiated Susceptibility-Electric Field	9
3.1.1	Test Description	9
3.1.2	Test Procedure	9
3.1.3	Test Results	9
3.1.4	Test Configuration Photograph	9
3.2	IEC 1000-4-4, Electrical Fast Transient/Burst Susceptibility	11
3.2.1	Test Description	11
3.2.2	Test Procedure	11
3.2.3	Test Results	11
3.2.4	Test Configuration Photograph	11
3.3	IEC 1000-4-6, Conducted RFI Susceptibility	14
3.3.1	Test Description	14
3.3.2	Test Procedure	14
3.3.3	Test Results	14
3.3.4	Test Configuration Photograph	14
3.4	IEC 1000-4-8, Power Frequency Magnetic Field Susceptibility	16
3.4.1	Test Description	16
3.4.2	Test Procedure	16
3.4.3	Test Results	16
3.4.4	Test Configuration Photograph	16

**Table of Contents, cont'd.**

4.0	Conclusions	18
4.1	IEC1000-4-2, Electrostatic Discharge Susceptibility	18
4.2	ENV50140, Radiated Susceptibility - Electric Field	18
4.3	IEC1000-4-4, Electrical Fast Transient/Burst Susceptibility	18
4.4	IEC1000-4-6, Conducted RFI Susceptibility	18
4.5	IEC1000-4-8, Power Frequency Magnetic Field Susceptibility	18
4.6	EN50082-2, Generic Immunity Standard Part 2: Industrial Environment	18

**List of Tables**

Table 1.3-1	Results Summary/Modifications	2
Table 1.4-1	Test Parameters	3
Table 2.3-1	Test Equipment	5

**Illustrations**

3.0-1	Test Configuration Photograph, IEC1000-4-2	8
3.1-1	Test Configuration Photograph, ENV50140	10
3.2-1	Test Configuration Photograph, IEC1000-4-4 (direct injection)	12
3.2-1	Test Configuration Photograph, IEC1000-4-4 (capacitive coupling)	13
3.3-1	Test Configuration Photograph, IEC1000-4-6	15
3.4-1	Test Configuration Photograph, IEC1000-4-8	17

TT7800

---

Inchcape Testing Services

---

**1.0 Introduction**

**1.1 Scope**

This report covers testing performed on the Model TT7800-401 and TT7800-501 electro-pneumatic transducers manufactured by Fairchild IPC, Inc..

**1.2 Purpose**

Testing was performed to evaluate the Model TT7800-401 and TT7800-501 electro-pneumatic transducers for susceptibility to ESD, radiated RFI, conducted RFI, electrical fast transients/bursts, and power frequency magnetic fields in accordance EN50082-2

**1.3 Summary**

The Model TT7800-401 and TT7800-501 electro-pneumatic transducers were found to be immune to ESD, radiated RFI, conducted RFI, electrical fast transients/bursts, and power frequency magnetic fields in accordance with EN50082-2 when tested as received.

**1.4 Testing Requirements**

Testing was performed using procedures and criteria contained in IEC1000-4-2, IEC1000-4-4, IEC1000-4-6, IEC1000-4-8, ENV50140 and EN50082-2. Table 1.4-1 contains specifics pertaining to testing parameters.



Inchcape Testing Services

Table 1.3-1 Results Summary/Modifications

IEC 1000-4-2	
Results	Modifications
Passes $\pm 6$ kV Contact Discharge Passes $\pm 8$ kV Air Discharge	None

ENV 50140	
Results	Modifications
Passes 10V/m, 80% Amplitude Modulated w/1kHz sinewave from 80 to 1000 MHz Passes 10 V/m pulse modulated at 200 Hz to 50% duty cycle at $900 \pm 5$ MHz	None

IEC 1000-4-4	
Results	Modifications
Passes at $\pm 2$ kV	None

IEC 1000-4-6	
Results	Modifications
Passes $10 V_{rms}$ (80% AM w/ 1 kHz sinewave) on all power and signal lines	None

IEC 1000-4-8	
Results	Modifications
Passes $30 A_{rms}/m$ (continuous), 50 Hz magnetic field	None

Inchcape Testing Services

---

Table 1.4-1 Test Parameters/Compliance Criteria

- IEC 1000-4-2, Electrostatic Discharge Susceptibility  
± 6 kV contact discharge, ± 8 kV air discharge  
Category B Compliance per EN50082-2:1994
- ENV50140, Radiated Electromagnetic Field Susceptibility  
10 V/m, 80 to 1000 MHz (80% Amplitude Modulated w/1kHz sinewave)  
900±5 MHz, 10 V/m pulse modulated at 200 Hz to 50% duty cycle  
Category A Compliance per EN50082-2:1994
- IEC 1000-4-4, Electrical Fast Transient/Burst Susceptibility  
± 2 kV on all power and signal lines  
Category B Compliance per EN50082-2:1994
- IEC 1000-4-6, Conducted RF Disturbance Susceptibility  
10 V<sub>rms</sub> (80% AM w/ 1 kHz sinewave) on all power and signal lines  
Category A Compliance per EN50082-2:1994
- IEC 1000-4-8, Power Frequency Magnetic Field Susceptibility  
30 A<sub>rms</sub>/m (continuous) at 50 Hz  
Category A Compliance per EN50082-2:1994

## Inchcape Testing Services

---

### 2.0 Test Environment

#### 2.1 Test Sample Description

The Equipment Under Test (EUT) consisted of the Models TT7800-401 and TT7800-501 electro-pneumatic transducers. The Model T7800 Series of electro-pneumatic transducers is designed to transmit a pneumatic signal which is linearly proportional to a DC current or DC voltage input. The TT7800-401 is a current controlled unit while the TT7800-501 is controlled by voltage and current source inputs. The TT7800-401 was tested with the current source set to 12 mA, and the TT7800-501 was tested with the voltage input set to 24 VDC and the current source input adjusted to yield a 3 VDC drop across a 249 ohm resistor between the S+ and V- terminals. The input air pressure was regulated to 20 psi. This configuration resulted in a pneumatic pressure of approximately 9 psi at the output ports of each transducer. This pneumatic pressure was monitored during all EMC testing and was the criterion for performance degradation. A failure occurred if any disturbance caused the output pressure to vary more than  $\pm 0.06$  psi.

The test samples were received into the EMC test facility on May 25, 1995.

#### 2.2 Test Facility

The test facility, Inchcape Testing Services, is located at 4317-A Park Dr., Norcross, Georgia. EMC Test Site #2 is located in this building. EMC Test Site is located in the lower level of the free standing EMI site and consists of a shielded room (12' x 24' x 10'). Ambient temperature is maintained between 65 and 75°F, with an approximate relative humidity of 45%.

#### 2.3 Test Equipment

Table 2.3-1 contains a list of the test equipment used during the testing.

Inchcape Testing Services

Table 2.3-1 Test Equipment

IEC 1000-4-2		
Model No.	Serial No.	Description
Key-Tek MZ15	731865	ESD Simulator

ENV50140		
Model No.	Serial No.	Description
LCF 1200-10-10-35R	049406	RF Amplifier
ENI 5100L	490	RF Amplifier
Fluke 6071A	3685018	Signal Generator
EMCO 3143	9404-1031	Biconilog Antenna
AR FM2000	13609	Isotropic Field Monitor
AR FP2000	14055	Isotropic Field Probe
AR 888	12584	Gated Leveling Pre-Amp

IEC 801-4		
Model No.	Serial No.	Description
VELONEX V-3300	16509	Fast Transient/Burst Generator

Inchcape Testing Services

Table 2.3-1 (Continued)

IEC 1000-4-6		
Model No.	Serial No.	Description
Tektronix 465 Marconi 2022C AH Systems BCP-200/511 LCF 1200-10-10-35R ENI 240-L	B262681 119095/008 498 049406 369	Oscilloscope Signal Generator Current Injection Probe RF Amplifier RF Amplifier

IEC 1000-4-8		
Model No.	Serial No.	Description
Elgar 5162000-01 Rev. 05 ETL 1000-4-8-1 AH Systems SAS-200/560	213 N.A. 575	AC Power Source Induction Coil Magnetic Loop Antenna

**3.0 IEC 1000-4-2, Electrostatic Discharge Susceptibility**

**3.0.1 Test Description**

IEC Publication 1000-4-2:1991, Electromagnetic Compatibility Part 4: Testing and Measurement Techniques-Section 2: Electrostatic Discharge Immunity Test, Basic EMC Publication was the guiding document for this test. This test evaluates the test sample's response to electrostatic discharge events that occur to the body of the test sample at  $\pm 8$  kV discharged through air and  $\pm 6$  kV contact discharge.

**3.0.2 Test Procedure**

The ESD test level is set and discharges are applied to the conductive surface under the test sample, the conductive surface vertical to the test sample, and along all seams and control surfaces on the test sample. If a discharge occurs and an error is caused, the type of error, discharge level and location is recorded.

**3.0.3 Test Results**

Testing showed that the Model TT7800-401 and TT7800-501 transducers are immune to ESD up to and including  $\pm 8$  kV air discharge, and up to and including  $\pm 6$  kV contact discharge when tested as received.

**3.0.4 Test Configuration Photograph**

Figure 3.0-1 shows the testing configuration used.

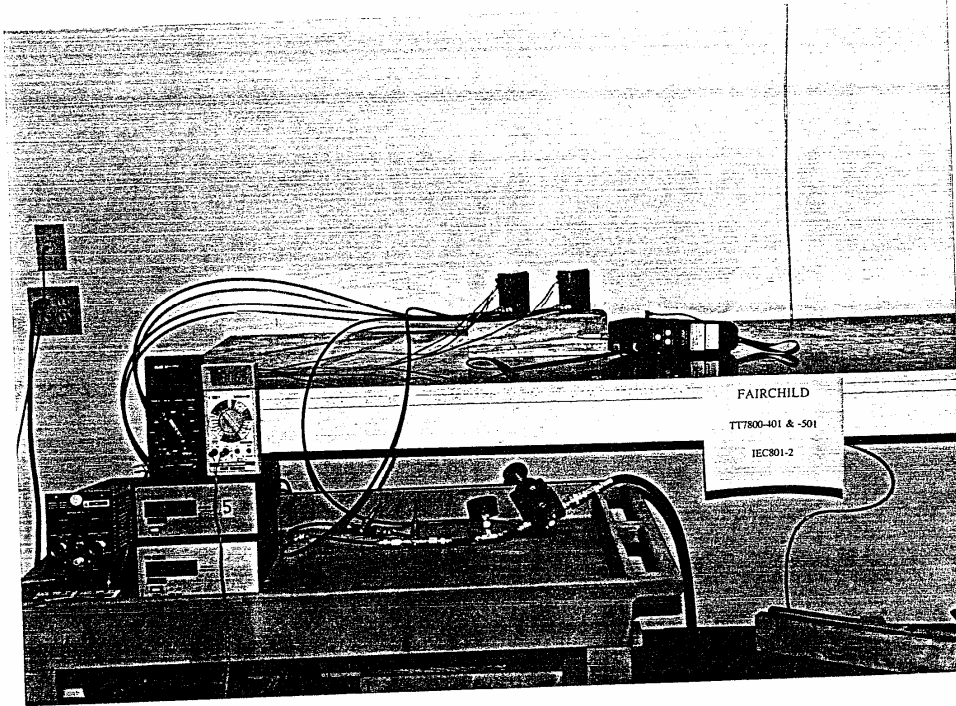

Figure 3.0-1 Test Configuration Photograph

**3.1 ENV50140, Radiated Susceptibility-Electric Field**

**3.1.1 Test Description**

CENELEC Publication ENV50140:1993, Electromagnetic Compatibility, Basic Immunity Standard for radiated, radio frequency electromagnetic field immunity, was the guiding document for this test. This test evaluates the test sample's response to radiated electric fields and was performed from 80 to 1000 MHz at a level of 10 V/m, 80% Amplitude Modulated w/ 1 kHz sinewave. The test was also performed at  $900 \pm 5$  MHz at an immunity level of 10 V/m pulse modulated at 200 Hz to 50% duty cycle.

**3.1.2 Test Procedures**

The test sample is set into operation and was monitored for variations in performance. The test signal is set for frequency, modulation level, and field strength. The procedure is performed by adjusting the transmitting antenna so that the electromagnetic field is vertically polarized while sweeping through the appropriate frequency range and maintaining the necessary field strength. This procedure is then repeated with the transmitting antenna adjusted to the horizontal polarization position. If an error is detected, the field strength is reduced until the error corrects, then increased until the error begins to occur. This threshold level, the frequency and the error created are noted before continuing.

**3.1.3 Test Results**

The Model TT7800-401 and TT7800-501 transducers were found to be immune to RFI at 10 V/m from 80 to 1000 MHz, 80% Amplitude Modulated w/ 1 kHz sinewave, in both antenna polarizations, when tested as received.

The test samples were also found to be immune to RFI at  $900 \pm 5$  MHz at an immunity level of 10 V/m pulse modulated at 200 Hz to 50% duty cycle when tested as received.

**3.1.4 Test Configuration Photograph**

Figure 3.1-1 shows the testing configuration used.



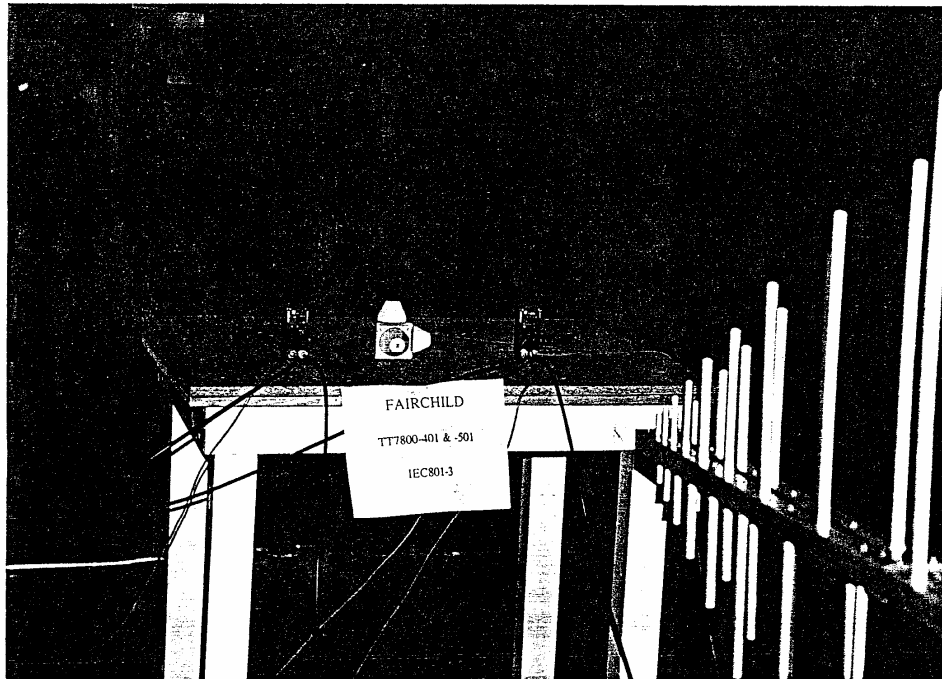

Figure 3.1-1 Test Configuration Photograph

**3.2 IEC 1000-4-4, Electrical Fast Transients/Bursts Susceptibility**

**3.2.1 Test Description**

IEC Publication 1000-4-4:1988, Electromagnetic Compatibility Part 4: Testing and Measurement Techniques-Section 4: Electrical Fast Transient/Burst Immunity Test was the guiding document for this test. This test evaluates the test sample's response to burst interference transients conducted on the power supply lines and signal lines to the EUT. A test signal of  $\pm 2.0$  kV was applied to all power and signal lines to the EUT.

**3.2.2 Test Procedure**

The test sample was connected to the test equipment, as shown in Figure 3.2-1, and monitored for performance. The transients were directly injected onto the DC power input lines to the test samples. Using a capacitive coupling clamp as called out in IEC1000-4-4, the transients were capacitively coupled onto signal and control lines to the test samples. This test configuration is shown in Figure 3.2-2. This coupling clamp provides the ability of coupling the fast transients/bursts to the circuit under test without any galvanic connection to the terminals of the circuits, shielding of the cables or any other part of the EUT. The equipment was monitored during testing for any degradation in performance. When an error or any degradation occurs, the test level is reduced until the condition corrects and then increased until the immunity threshold is reached. This threshold level and the error conditions are noted before continuing.

**3.2.3 Test Results**

Testing showed that the Model TT7800-401 and TT7800-501 are immune to conducted transients of up to  $\pm 2.0$  kV on power and signal lines when tested as received.

**3.2.4 Test Configuration Photograph**

Figures 3.2-1 and 3.2-2 show the testing configurations used.

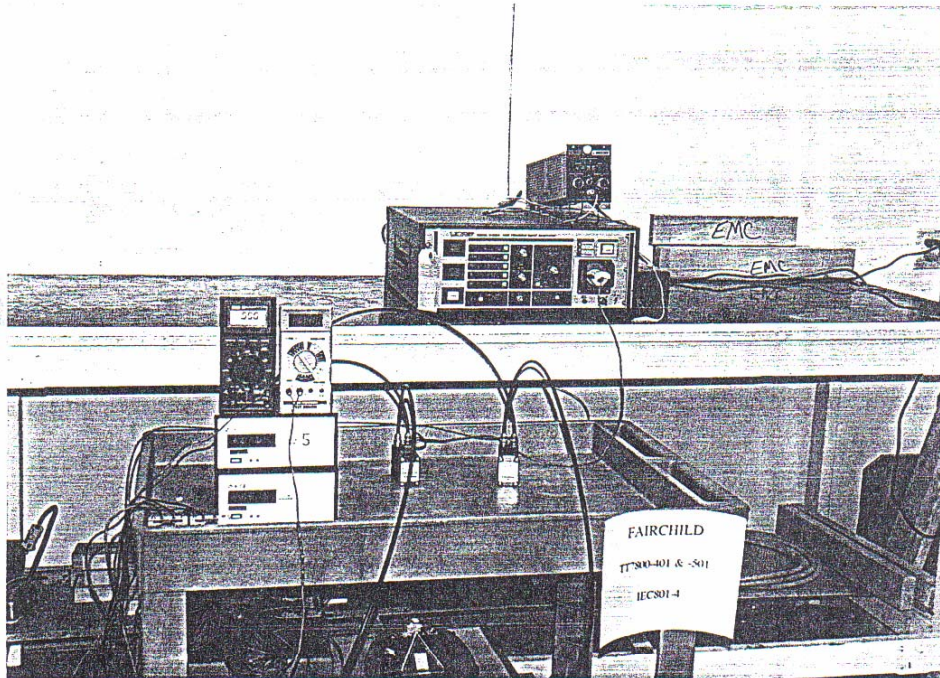

Figure 3.2-1 Test Configuration Photograph

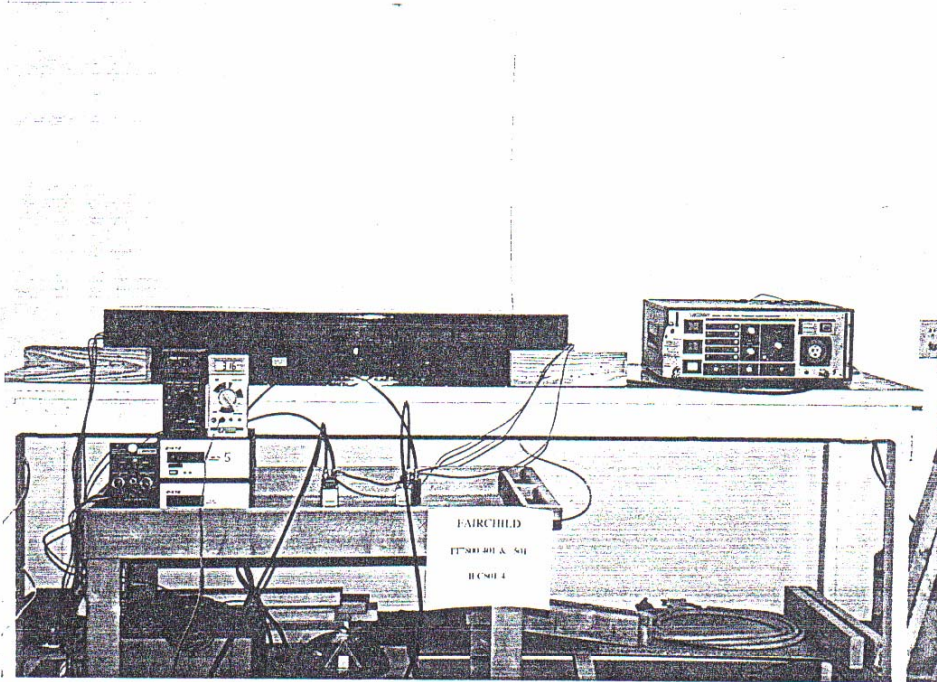

Figure 3.2-2 Test Configuration Photograph

**3.3 IEC 1000-4-6, Conducted RFI Susceptibility**

**3.3.1 Test Description**

IEC Publication 1000-4-6:1993, Electromagnetic Compatibility for Electrical and Electronic Equipment, Part 6: Immunity to Conducted Disturbances Induced by Radio Frequency Fields was the guiding document for this test. This test evaluates the test sample's response to conducted RF disturbances on power and signal lines.

**3.3.2 Test Procedure**

The test sample was connected to the test equipment, as shown in Figure 3.3-1, and monitored for performance. A current injection probe was used to inject the RF interference onto each of the power and signal lines to the test sample for a continuous sweep of the frequencies 150 kHz to 80 MHz. The test signal was set at 10 V<sub>rms</sub> and amplitude modulated 80% with a 1 kHz sinewave. The test was performed in differential and common mode.

**3.3.3 Test Results**

The Model TT7800-401 and TT7800-501 transducers were found to be immune to conducted RFI from 150 kHz to 80 MHz at 10 V<sub>rms</sub> (80% AM w/ 1 kHz sinewave) when tested as received.

**3.3.4 Test Configuration Photograph**

Figure 3.3-1 shows the testing configuration used.

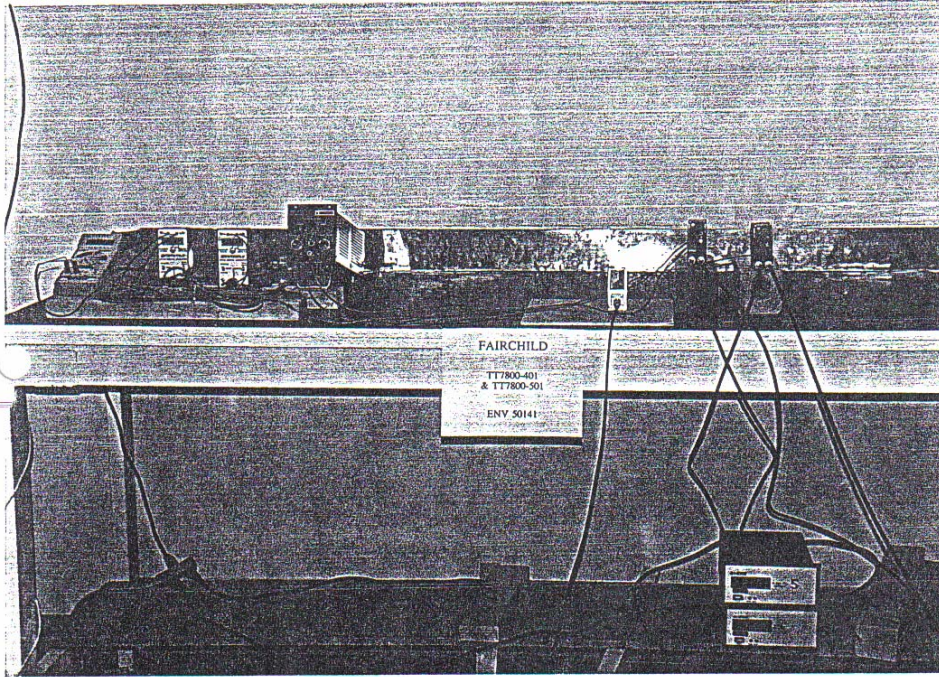

Figure 3.3-1 Test Configuration Photograph

**3.4 IEC 1000-4-8, Power Frequency Magnetic Field Susceptibility**

**3.4.1 Test Description**

IEC Publication 1000-4-8:1993, Electromagnetic Compatibility Part 4: Testing and Measurement Techniques Section 8: Power Frequency Magnetic Field Immunity Test was the guiding document for this test. This test evaluates the test sample's response to power frequency magnetic disturbances and was performed at a level of 30 A<sub>rms</sub>/m.

**3.4.2 Test Procedure**

The test sample was connected to the test equipment, as shown in Figure 3.4-1, and monitored for performance. A standard square induction coil (1 meter side) as called out in IEC1000-4-8 was used to apply a magnetic field to the test sample using the immersion method. The induction coil was positioned in three separate orthogonal positions for application of the magnetic field around the EUT. The power source was set to 50 Hz and voltage was applied to the induction coil until the magnetic field strength at the equipment under test reached 30 A<sub>rms</sub>/m. The magnetic field was applied to the EUT at the specified immunity level for one minute. The test samples were monitored for any degradation in performance. If any degradation of performance occurred, the immunity threshold and error conditions were noted.

**3.4.3 Test Results**

The Model TT7800-401 and TT7800-501 transducers were found to be immune to power frequency magnetic disturbances at a level of 30 A<sub>rms</sub>/m when tested as received.

**3.4.4 Test Configuration Photograph**

Figure 3.4-1 shows the testing configuration used.

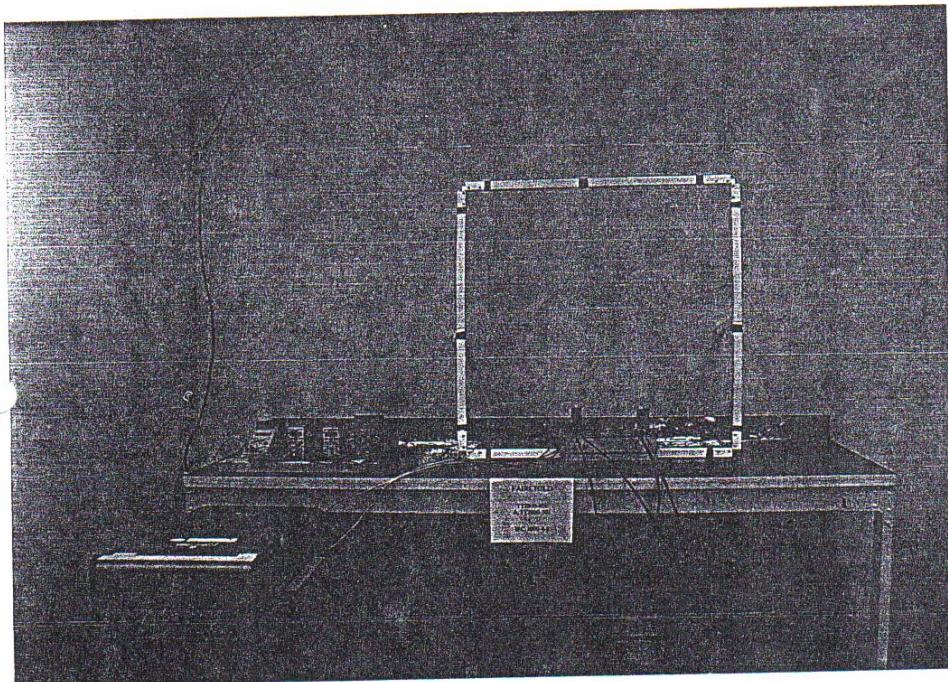

Figure 3.4-1 Test Configuration Photograph



TT7800

4.0 Conclusions

4.1 IEC 1000-4-2, ESD Susceptibility

The Model TT7800-401 and TT7800-501, manufactured by Fairchild IPC, Inc., were found to be immune to ESD up to and including 6 kV contact discharge and 8 kV air discharge when tested as received.

4.2 ENV50140, Radiated Susceptibility - Electric Field

The Model TT7800-401 and TT7800-501, manufactured by Fairchild IPC, Inc., were found to be immune to RFI at 10 V/m from 80 to 1000 MHz (80% Amplitude Modulated w/ 1kHz sinewave), in either antenna polarization when tested as received.

The Model TT7800-401 and TT7800-501, manufactured by Fairchild IPC, Inc., were found to be immune to RFI at  $900 \pm 5$  MHz at an immunity level of 10 V/m pulse modulated at 200 Hz to 50% duty cycle when tested as received.

4.3 IEC 1000-4-4, Electrical Fast Transients/Bursts Susceptibility

The Model TT7800-401 and TT7800-501, manufactured by Fairchild IPC, Inc., were found to be immune to  $\pm 2.0$  kV transients on all power and signal lines when tested as received.

4.4 IEC 1000-4-6, Conducted RFI Susceptibility

The Model TT7800-401 and TT7800-501, manufactured by Fairchild IPC, Inc., were found to be immune to conducted RFI at  $10 V_{rms}$  from 150 kHz to 80 MHz (80% AM w/ 1 kHz sinewave) when tested as received.

4.4 IEC 1000-4-8, Power Frequency Magnetic Field Susceptibility

The Model TT7800-401 and TT7800-501, manufactured by Fairchild IPC, Inc., were found to be immune to power frequency magnetic fields at  $30 A_{rms}/m$  (continuous) when tested as received.

4.2 EN50082-2, Generic Immunity Standard, Part 2: Industrial Environment

The Model TT7800-401 and TT7800-501, manufactured by Fairchild IPC, Inc., comply with the immunity requirements of EN50082-2 when tested as received.

**Fairchild IPC, Inc.**

Emissions Testing  
Performed  
on the  
**Electro-Pneumatic Transducers**  
**Model: TT7800-401 & TT7800-501**  
EN55011 Group 1 Class A

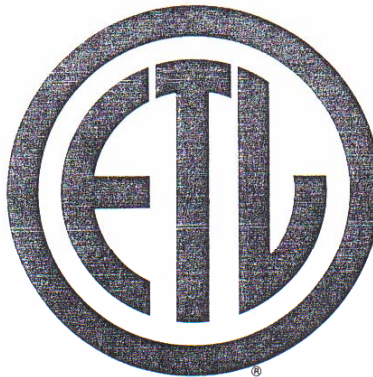

SINCE 1896

**ETL Testing Laboratories, Inc.**

---

*ETL is an independent testing and certification organization.*



**Inchcape Testing Services**  
ETL Testing Laboratories, Inc.

Inchcape Testing Services  
4317-A Park Dr., N.W.  
Norcross, GA 30093  
Telephone (404) 925-2444  
Fax (404) 925-7294

Fairchild IPC, Inc.

Emissions Testing  
Performed  
on the

**Electro-Pneumatic Transducers**  
**Model: TT7800-401 & TT7800-501**  
EN55011 Group 1 Class A

Date of Test: June 27, 1995

WO#1408  
SM/si  
Report #551639  
July 7, 1995  
DOT: June 27, 1995  
Contact: Stan Przybylowicz

Total No. of Pages Contained in this Report: 22

All services undertaken are subject to the following general policy:  
Reports are submitted for exclusive use of the client to whom they are  
addressed. Their significance is subject to the adequacy and  
representative character of the samples and to the comprehensiveness of  
the tests, examinations or surveys made. No quotations from reports or  
use of Inchcape Testing Services' name is permitted except as expressly  
authorized by Inchcape Testing Services in writing.

ETL TESTING LABORATORIES, INC.  
4317-A Park Drive, NW  
Norcross, GA 30093

## VERIFICATION

Fairchild IPC, Inc.  
3920 West Point Blvd.  
Winston Salem, NC 27102

July 7, 1995

### NOT TRANSFERABLE

Verification is hereby issued to the named GRANTEE and is VALID ONLY for the equipment identified hereon for use under the rules and regulations listed below.

Name of Grantee: Fairchild IPC, Inc.

Model or FCC Identifier: TT7800-401 & TT7800-501

Applicable Regulation: Applicable to EC Directive 89/336/EEC

Equipment Class: Group 1 Class A

Note(s):

- (1) See attached Report dated July 7, 1995 for details and/or conditions of this Verification.
- (2) Test methods employed conform to the Standard Operating Procedures of ETL Testing Laboratories, Inc.
- (3) Verified to the limits and methods of EN 55011.

Accredited by the National Institute of Standards and Technology  
for Emissions and Telecommunications Testing  
Approved by the Canadian Department of Communications for Telecom Testing

In correspondence concerning this Verification,  
please refer to the date, Grantee Name and Model No.

## INCHCAPE TESTING SERVICES

---

### Table of Contents

1.0	<b>Introduction and Conclusions</b> . . . . .	1
2.0	<b>Description of the Product</b> . . . . .	4
2.1	Brief Description and Received Condition . . . . .	4
2.2	System Block Diagram . . . . .	4
2.3	System Test Configuration . . . . .	5-6
2.4	Justification . . . . .	7
2.5	EUT Operation and Exercise . . . . .	7
2.6	Modifications Required for Compliance . . . . .	7
3.0	<b>Electromagnetic Radiation Disturbance</b> . . . . .	8
3.1	Limits of Electromagnetic Radiation Disturbance . . . . .	8
3.2	Site Description and List of Test Equipment . . . . .	10
3.3	Field Strength Calculation . . . . .	11
3.4	Configuration Photographs . . . . .	12
3.5	Test Data . . . . .	14
4.0	<b>Miscellaneous Information</b> . . . . .	15
4.1	Test Report Certification . . . . .	16
4.2	Terms and Conditions . . . . .	17

## INCHCAPE TESTING SERVICES

---

*This report is designed to show compliance with the European Standard EN55011:1991, Limits and methods of measurement of radio disturbance characteristics of industrial, scientific and medical (ISM) radio-frequency equipment. The test procedures, as described in EN55011, were employed. A description of the product and operating configuration, the various provisions of the rules, the methods for determining compliance, and a detailed summary of the results are included within this test report.*

### 1.0 Introduction and Conclusions

#### A. Introduction:

EN55011:1991 recognizes two types (groups) of equipment, as well as two different environments and requires the manufacturer to label the product accordingly:

Group 1
Contains all ISM equipment in which there is intentionally generated and/or used conductively coupled radio frequency energy which is necessary for the internal functioning of the equipment itself. Typical examples are signal generators, flow meters, spectrum analyzers and switch mode power supplies (when not incorporated into equipment).

Group 2
Contains ISM equipment in which radio frequency energy is intentionally generated and/or used in the form of radiation for the treatment of material. Typical examples are RF gluing, heating, welding and drying equipment, domestic microwave ovens and induction cookers.

EN55011 Class A equipment is intended for use in commercial and industrial locations. Class B equipment is suitable for use in domestic environments. Radiated emission limits have been established for both groups and classes from 30 MHz to 12.7 GHz. Line-conducted emissions are specified for both groups and classes from 150 kHz to 30 MHz. Additionally, there exist magnetic emission limits only for Group 2 Class A equipment from 150 kHz to 30 MHz.

## INCHCAPE TESTING SERVICES

---

### 1.0 Introduction and Conclusions (Continued)

EN55011 is the acceptance of ISM frequency bands within which there are no maximum radiation limits. Not all of these frequencies are available worldwide; they are referenced to regions established by the International Telecommunications Union (ITU) and are listed in the Table attached.

Frequencies designated by ITU for use as fundamental ISM frequencies<sup>1)</sup>

Center Frequency  MHz	Frequency Range  MHz	Maximum radiation limit <sup>2)</sup>	Number of appropriate footnote to the table of frequency allocation to the ITU Radio Regulations
6.780	6.765 - 6.795	Under consideration	524 <sup>2)</sup>
13.560	13.553 - 13.567	Unrestricted	534
27.120	26.957 - 27.283	Unrestricted	546
40.680	40.66 - 40.70	Unrestricted	548
433.920	433.05 - 434.79	Under consideration	661 <sup>2)</sup> , 662
2450	2400 - 2500	Unrestricted	752
5800	5725 - 5875	Unrestricted	806
24125	24000 - 24250	Unrestricted	881
61250	61000 - 61500	Under consideration	911 <sup>2)</sup>
122500	122000 - 123000	Under consideration	916 <sup>2)</sup>
245000	244000 - 246000	Under consideration	922 <sup>2)</sup>

- (1) Resolution No. 63 of the ITU Radio Regulations Applies
- (2) Use of these frequency bands is subject to special authorization by administrations concerned in agreement with other administrations whose radio communication services might be affected.
- (3) The term "unrestricted" applies to the fundamental and all other frequency components falling within the designated band. Special measures to achieve compatibility may be necessary where other equipment satisfying immunity requirements (e.g. CISPR 20, IEC 801), is placed close to ISM equipment.

INCHCAPE TESTING SERVICES

EN55011  
EMISSIONS

1.0 Introduction and Conclusions (Continued)

Frequencies designated on a national basis in CENELEC countries for use as fundamental ISM frequencies

Frequency MHz	Maximum radiation limit <sup>1)</sup>	Notes
0.009 - 0.010	unlimited	Germany only
3.370 - 3.410	unlimited	Netherlands only
13.533 - 13.553	110 dB(uV/m) at 100m	United Kingdom only
13.567 - 13.587	110 dB(uV/m) at 100m	United Kingdom only
83.996 - 84.004	130 dB(uV/m) at 30m	United Kingdom only
167.992 - 168.008	130 dB(uV/m) at 30m	United Kingdom only
886.000 - 906.000	120 dB(uV/m) at 30m	United Kingdom only

1) distance measured from the exterior wall outside the building in which the equipment is situated.

B. Conclusions:

On June 27, 1995, we tested the Electro-Pneumatic Transducers, Model: TT7800-401 & TT7800-501, to determine if they were in compliance with the EN55011 Group 1 Class A emissions limits. We found that the unit met the EN55011 Group 1 Class A requirements when tested as received.

No radiated emissions were detected above the measuring equipment noise floor, which is at least 6 dB below the applicable limit.

No line-conducted tests were performed because the unit is DC powered.

In summary, this report verifies that the Electro-Pneumatic Transducers, Model: TT7800-401 & TT7800-501, are compliant with the EN55011 Group 1 Class A requirements when production units conform to the initial sample. Please address all questions and comments concerning this report to Jeffrey W. Whitmire, EMI Team Leader.



## INCHCAPE TESTING SERVICES

### 2.0 Description of the Product

#### 2.1 Brief Description and Received Condition

Prototype versions of the T7800 series of electro-pneumatic transducers were received on June 27, 1995 in good condition. The transducers transmit a pneumatic signal which is linearly proportional to a DC current or DC voltage input.

#### 2.2 System Block Diagram

The diagram shown below details the placement of the equipment under test on the turntable.

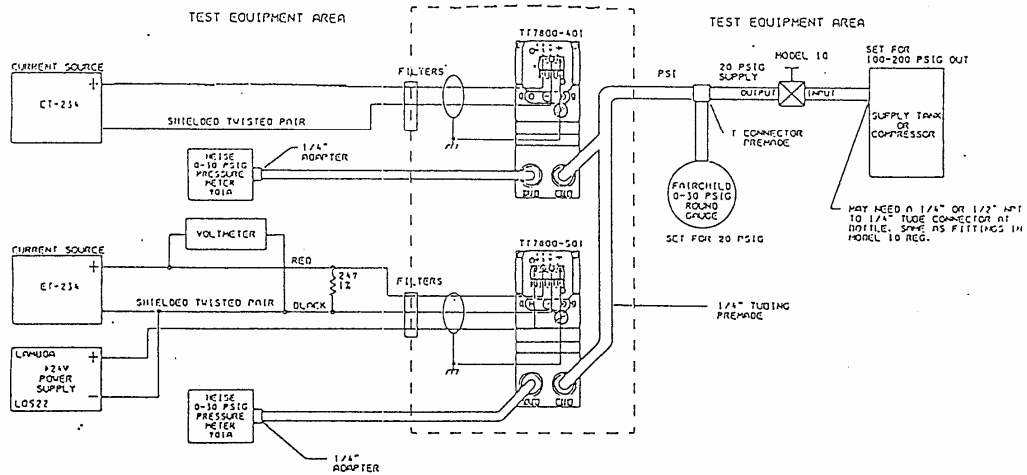

## INCHCAPE TESTING SERVICES

---

### 2.3 System Test Configuration

<b>Equipment Under Test:</b>	Electro-Pneumatic Transducers
<b>Model:</b>	TT7800-401 & TT7800-501
<b>Serial No.:</b>	Not Labelled
<b>FCC Identifier:</b>	not shown
<b>Support Equipment:</b>	
0-100Psi Differential	Heise M/N: 710A 100Psi S/N: 57-5121 FCC ID: n/a
0-30 Psi Differential	Heise M/N: 710A 30 Psi S/N: 57-5122 FCC ID: n/a
Power Supply	Lambda M/N: LG-522 S/N: 42904 FCC ID: n/a
Current Source	Fairchild      Quantity 2 M/N: ET234 S/N: n/a FCC ID: n/a
Multi-Meter	BK-Precision M/N: 388-HD S/N: 18302450 FCC ID: n/a

## INCHCAPE TESTING SERVICES

---

### 2.3 System Test Configuration, cont'd.

Pressure Regulator      Fairchild  
                                 M/N: 10  
                                 S/N: 10262  
                                 FCC ID: n/a

#### Cables:

3 AC Line (1m bundled, unshielded)  
2 Wire (1m, unshielded)  
3 Leads (1', unshielded)  
2 Meter Leads (1', unshielded)  
1 49-ohm Resistor

## INCHCAPE TESTING SERVICES

---

### 2.4 Justification

To insure maximum emissions were detected, the system was rotated 360 degrees, the antenna height was varied from 1 to 4 meters above the ground plane in both horizontal and vertical polarizations. These maximum emissions are represented in Exhibit 3.0.

### 2.5 EUT Operation and Exercise

There was no special software to exercise the device.

### 2.6 Modifications Required for Compliance

No modifications were installed during test performance to bring the product into compliance (Please note that this list does not include changes made specifically by Fairchild IPC, Inc. prior to compliance testing).

## INCHCAPE TESTING SERVICES

---

### 3.0 Electromagnetic Radiation Disturbance

#### 3.1 Limits of Electromagnetic Radiation Disturbance

**Electromagnetic radiation disturbance limits for Group 1 equipment**

Frequency band MHz	Measures on a test site		Measures in situ
	Group 1 Class A 30 m measurement distance  dB(uV/m)	Group 1 Class B 10 m measurement distance  dB(uV/m)	Group 1 Class A limits with measuring distance 30 m from exterior wall outside the building in which the equipment is situated dB(uV/m)
0.15 - 30	Under consideration	Under consideration	Under consideration
30 - 230	30	30	30
230 - 1000	37	37	37

**Electromagnetic radiation disturbance limits for  
Group 2 Class B equipment measured on a test site**

Frequency band MHz	Class B limits measurement distance 10 m dB(uV/m)
0.15 - 30	Limits under consideration
30 - 80.872	30
80.872 - 81.848	50
81.848 - 134.786	30
134.876 - 136.414	50
136.414 - 230	30
230 - 1000	37

## INCHCAPE TESTING SERVICES

### 3.1 Limits of Electromagnetic Radiation Disturbance (Continued)

Electromagnetic radiation disturbance limits for Group 2 Class A equipment

Frequency range MHz	Limits with measuring distance 30 m	
	From exterior wall outside the building in which the equipment is situated dB(uV/m)	On a test site dB(uV/m)
0.15 - 0.49	75	85
0.49 - 1.705	65	75
1.705 - 2.194	70	80
2.194 - 3.95	65	75
3.95 - 20	50	60
20 - 30	40	50
30 - 47	48	58
47 - 68	30	40
68 - 80.872	43	53
80.872 - 81.848	58	68
81.848 - 87	43	53
87 - 134.786	40	50
134.785 - 136.414	50	60
136.414 - 156	40	50
156 - 174	54	64
174 - 188.7	30	40
188.7 - 190.979	40	50
190.979 - 230	30	40
230 - 400	40	50
400 - 470	43	53
470 - 1000	40	50

*Note: Three sets of units are commonly used for EMI measurement, decibels below one milliwatt (-dBm), decibels above a microvolt (dBμV), and microvolts (μV). To convert between them, use the following formulas:  $20 \text{ LOG}_{10}(\mu\text{V}) = \text{dB}\mu\text{V}$ ,  $\text{dBm} = \text{dB}\mu\text{V}-107$ .*

## INCHCAPE TESTING SERVICES

---

### 3.2 Site Description and List of Test Equipment

The North site is located at 4317-A Park Drive in Norcross, Georgia. The site consists of a wooden enclosed structure with a steel ground plane. The site meets the characteristics of CISPR 16 and ANSI C63.4: 1991 and is on file with the FCC. For measurements a remotely controlled flush mount metal top turntable is used to rotate the EUT a full 360 degrees. A remote controlled non-conductive antenna mast is used to scan from one to four meter height. The site enclosure is constructed of non conductive materials.

Measurement equipment used for radiated emission compliance testing utilized some of the equipment on the following list:

Type	Manufacturer	Model Number	Serial Number
Spectrum Analyzer	Hewlett Packard	HP8595E	3249A00243
Spectrum Analyzer	Hewlett Packard	8558B/182 Mainframe	TE-43132
Signal Generator	Hewlett Packard	HP8640B	1814A08238
Preamplifier	Compliance Design	P950	EMC-0001
Preamplifier	Compliance Design	P950	EMC-0002
Preamplifier	Compliance Design	P1000	EMI-P10GHz
Preamplifier	Hewlett Packard	HP8447D	2237109
Horn Antenna	EMCO	3115	9208-3919
Horn Antenna	EMCO	3116	9310-2222
Loop Antenna	EMCO	6507	9204-1283
Tuned Dipole Ant.	Compliance Design	Roberts A100	423
Tuned Dipole Ant.	Compliance Design	Roberts A100	727
Biconical Antennas	Compliance Design	B1000	367, 406, 434
Biconical Antennas	Compliance Design	B1000	685, 454, 725
Biconical Antennas	Compliance Design	B1000	525, 536, 511
Antenna Mast	Compliance Design	M100	Mast 01
Antenna Mast	Compliance Design	M100	Mast 02

## INCHCAPE TESTING SERVICES

---

### 3.3 Field Strength Calculation

The field strength is calculated by adding the Antenna Factor and Cable Factor, and subtracting the Amplifier Gain (if any) from the measured reading. The basic equation with a sample calculation is as follows:

$$FS = RA + AF + CF - AG$$

where FS = Field Strength in  $\text{dB}\mu\text{V}/\text{m}$   
RA = Receiver Amplitude (including preamplifier) in  $\text{dB}\mu\text{V}$   
CF = Cable Attenuation Factor in dB  
AF = Antenna Factor in dB  
AG = Amplifier Gain in dB

In the following table(s), the reading shown on the data table reflects the preamplifier gain. An example for the calculations in the following table is as follows:

$$FS = RR + LF$$

where FS = Field Strength in  $\text{dB}\mu\text{V}/\text{m}$   
RR = RA - AG in  $\text{dB}\mu\text{V}$   
LF = CF + AF in dB

Assume a receiver reading of  $52.0 \text{ dB}\mu\text{V}$  is obtained. The antenna factor of 7.4 dB and cable factor of 1.6 dB is added. The amplifier gain of 29 dB is subtracted, giving a field strength of  $32 \text{ dB}\mu\text{V}/\text{m}$ . This value in  $\text{dB}\mu\text{V}/\text{m}$  was converted to its corresponding level in  $\mu\text{V}/\text{m}$ .

$$\begin{aligned} RA &= 52.0 \text{ dB}\mu\text{V}/\text{m} & RR &= 23.0 \text{ dB}\mu\text{V} \\ AF &= 7.4 \text{ dB} & LF &= 9.0 \text{ dB} \\ CF &= 1.6 \text{ dB} \\ AG &= 29.0 \text{ dB} \\ FS &= RR + LF \\ FS &= 23 + 9 = 32 \text{ dB}\mu\text{V}/\text{m} \end{aligned}$$

$$\text{Level in } \mu\text{V}/\text{m} = \text{Common Antilogarithm } [(32 \text{ dB}\mu\text{V}/\text{m})/20] = 39.8 \mu\text{V}/\text{m}$$



## INCHCAPE TESTING SERVICES

---

### 3.4 Configuration Photographs

Radiated Emission

Front View

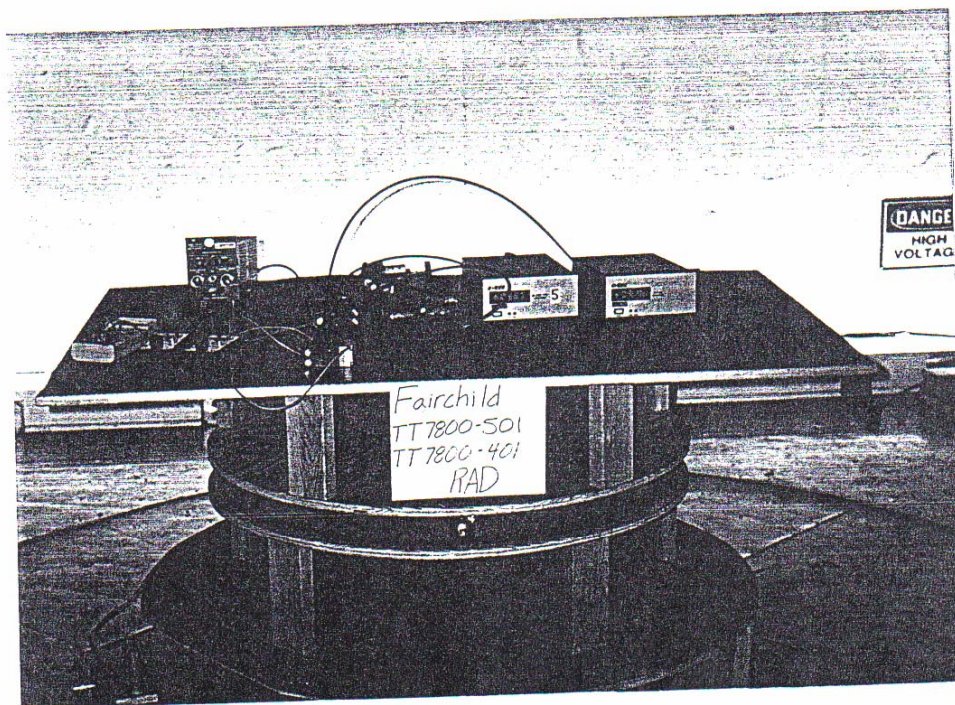

## INCHCAPE TESTING SERVICES

---

### 3.4 Configuration Photographs (continued)

Radiated Emission

Rear View

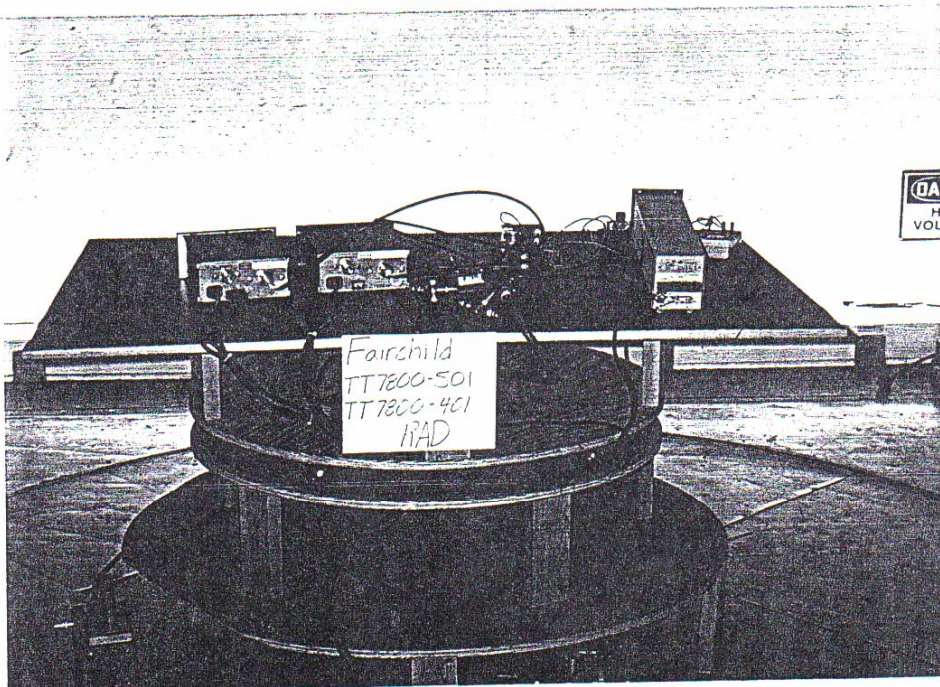

## INCHCAPE TESTING SERVICES

---

### 3.5 Test Data

The results on the following page(s) were obtained when the device was tested in the condition described in Section 2.

## ETL TESTING LABORATORIES, INC.

---

Table:1

Company: Fairchild

Model: Piezo Electric

Notes: Initial Results, TT7800-501 and TT7800-401

CISPR 11 Gp 1 Class A Radiated Emissions

Antenna Polarity	Frequency (MHz)	Reading (dBuV)	Antenna Factor (dB)	Net at 30 meter (dBuV/m)	Class A Limit (dBuV/m)	Margin (dB)

No Radiated emissions were detected above  
the measuring equipment noise floor, which is at  
least 6 dB below the applicable limit.

Test Engineer: Steve McKinney

Test Date: 06-27-1995

**INCHCAPE TESTING SERVICES**

---

**4.0 Miscellaneous Information**

## INCHCAPE TESTING SERVICES

---

### 4.1 Test Report Certification

**Company Name:** Fairchild IPC, Inc.  
3920 West Point Blvd.  
Winston Salem, NC 27102

**Attention:** Stan Przybylowicz

**Model No.:** TT7800-401 & TT7800-501

**Report Date:** July 7, 1995

**Test Site Location:** INCHCAPE TESTING SERVICES  
4317-A Park Dr., N.W.  
Norcross, Georgia 30093

We attest to the accuracy of this report:

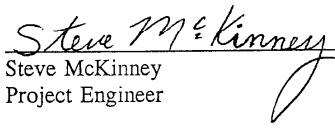
  
Steve McKinney  
Project Engineer

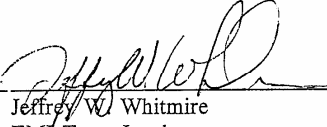
  
Jeffrey W. Whitmire  
EMI Team Leader

**Table 1 Model T7800 Immunity Standards, Test Requirements & Performance Criteria**

Standards	Models	Test Specs.s	Perf. Criteria
EN 61326-1:1998 Immunity Annex A (normative)	T7800		
<b>Table A.1: Enclosure Port</b>			
ESD: EN 61326: 1998 <i>Passed in original submittal 7/95</i>	N/A	4 kV Contact 8 kV air discharge	N/A
<b>EM Field: EN 61000-4-3:1997 (IEC 1000-4-3) + A1:1998 Amendment (Radiated RF) RF-EMF AM</b>	X	<b>80-1000MHz &amp; 1.4-2.0GHz Level 3: 10 V/M 80% AM (1KHz)</b>	<b>A</b>
Mag Fields: EN 61000-4-8:1993 Power Frequency Magnetic Field <i>Passed in original submittal 7/95</i>	N/A	50 Hz 30 A(rms)/m	N/A
<b>Table A.1: DC Power Port</b>			
Burst: EN 61000-4-4:1995 Fast Transients <i>Passed in original submittal 7/95</i>	N/A	2 kV (peak) 5/50 Tr/Th ns 5 kHz Repeat Frequency	N/A
<b>ⓐ Surge: EN 61000-4-5:1995 + A1:1996 (or latest)</b>	X	<b>1.2/50 (8/20) Tr/Th uS Common Mode 2kV (Line to Grnd) Differential Mode 1kV (Line to Line)</b>	<b>B</b>
Conducted RF EN 61000-4-6:1997 (IEC 1000-4-6) RF Common Mode AM <i>Passed in original submittal 7/95</i>	N/A	0.15 - 80 MHz <u>10V (rms, unmodulated)</u> 80% AM (1KHz) 150 Source Impedance Ohms	N/A
<b>Table A.1: I/O Signal/Control Port</b>			
Burst: EN 61000-4-4:1995 Fast Transients <i>Passed in original submittal 7/95</i>	N/A	2 kV (peak) 5/50 Tr/Th ns 5 kHz Repeat Frequency	N/A
<b>ⓐ Surge: EN 61000-4-5:1995 + A1:1996 (or latest)</b>	X	<b>1.2/50 (8/20) Tr/Th uS Differential Mode 1kV (Line to Line)</b>	<b>B</b>
Conducted RF EN 61000-4-6:1997 (IEC 1000-4-6) RF Common Mode AM <i>Passed in original submittal 7/95</i>	N/A	0.15 - 80 MHz <u>10V (rms, unmodulated)</u> 80% AM (1KHz) 150 Source Impedance Ohms	N/A
<b>Table A.1: I/O Signal/Control Port - Connected Directly to Power Supply Network</b>		<b>ⓐ This Section Not Applicable, No AC Power</b>	
Burst: EN 61000-4-4:1995 Fast Transients	N/A	2 kV (peak) 5/50 Tr/Th ns 5 kHz Repeat Frequency	N/A
Surge: EN 61000-4-5:1995 + A1:1995	N/A	1.2/50 (8/20) Tr/Th uS Differential Mode 1kV (Line to Line)	N/A
Conducted RF: EN 61000-4-6:1997 (IEC 1000-4-6) RF Common Mode AM	N/A	0.15 - 80 MHz <u>10V (rms, unmodulated)</u> 80% AM (1KHz) 150 Source Impedance Ohms	N/A

Notes:

- ① Surge Immunity is tested in DC Power Port and I/O Signal/Control Ports. This allows testing to be performed on both ports simultaneously.
- ② AC Power Port is not applicable to these devices since there is no AC power connected to units.
- ③ Bold sections indicate required tests.

**Table 2 Model T7800 Emission Standards & Test Requirements: Class A Equipment**

Standards	Models	Test Spec.s	Performance Criteria
<b>EN 61326:1998 Emission</b> ① <b>Table 3</b>			
EN 61326:1998	T7800	Frequency generating part of circuit is unchanged.	
<b>Table 3: Ports for Enclosure and AC Mains</b>			
<b>EN 61326:1998 Enclosure</b>	<b>X</b>	<b>30-230 MHz: 40 db (uV/m) Quasi peak, measured at 10m distance</b> <b>230-1000 MHz: 47 db (uV/m) Quasi peak, measured at 10m distance</b>	<b>Limits in Test Spec.s - Table 3</b>
EN 61326:1998 AC Mains	N/A	0.15 - 0.50 MHz: 79db (uV) quasi peak & 66db (uV) average 0.5 - 5 MHz: 73db (uV) quasi peak & 60db (uV) average 5 - 30 MHz: 73db (uV) quasi peak & 60 db (uV) average	N/A

① AC Power Port is not applicable to these devices since there is no AC power connected to units.

② **Bold sections indicate required tests.**

N/A Not Applicable

**Table 3 Model T7800 EMC Test Setup Input/Output Values & Limits for Performance Criteria A**

Model	Test Input	Pressure Output①	Power Supply	Pressure Limits
TT7800-401	12.0mA	9PSIG	N/A	+/-0.5%FS (+/-0.06psig)
TD7800-401	12.0mA	9PSIG	N/A	+/-0.5%FS (+/-0.06psig)
TT7800-901	5V	9PSIG	24Vdc +/-10%	+/-0.5%FS (+/-0.06psig)
TD7800-901	5V	9PSIG	24Vdc +/-10%	+/-0.5%FS (+/-0.06psig)

① Typical values. Record Actual readings.

**Table 4 Model T7800 Surge Test Sequence Based on Pass/Fail**

Step	Model	Input Type	Surge Suppressors	Test	Go To Step	Comment
①	TT7800-401	15 mA	2 SMBJ5349B	Pass Fail	3 2	Selected for Compatibility with Intrinsic Safety Requirements
②	TD7800-401	12 mA	2 SMBJ12A	Pass Fail	3 3	
3	TT7800-901	5 V	2 SMBJ28A + 1 SMBJ12A	Pass Fail	Stop Stop	



# ITS Intertek Testing Services

## Facsimile Cover Sheet

1950 Evergreen Boulevard Suite 100, Duluth, Georgia 30096  
 Telephone 678-775-2400 Fax 678-775-2401  
<http://www.etsenko.com>

To	Stan Przybylowicz	From	David J. Schramm
Company	Fairchild Industrial Products	Email	<a href="mailto:dschramm@itsqs.com">dschramm@itsqs.com</a>
Fax#:	(336) 659 - 9356	Date	May 1, 2001
Pages:	1 (including cover page)	cc:	Michael Lehman
Re:	Status of TT 7800-401 and TT7800-901		

Stan,

Here is the status of the EMC testing for the TT 7800-401 and TT 7800-901.

Test	Result	
	TT 7800-401	TT 7800-901
Radiated Emissions	Pass	Pass
Radiated Immunity	Pass	Pass
Surge	Fail	Fail

If you have any questions or need additional information, please do not hesitate to call me.

Best regards,  
 David Schramm



Confidentiality Notice: The information contained in this facsimile transmittal is privileged and confidential. It is intended only for the use of the addressee. If the reader of this message is not the intended recipient, or person responsible to deliver it to the intended recipient, you are hereby notified that any dissemination, distribution or copy of this facsimile transmittal is strictly prohibited. If you have received this transmittal in error, please notify us immediately by telephone and please return the original transmittal to the address above. Thank you.

# ITS Intertek Testing Services

## Facsimile Cover Sheet

1950 Evergreen Boulevard Suite 100, Duluth, Georgia 30096  
 Telephone 678-775-2400 Fax 678-775-2401  
<http://www.etlsemko.com>

To:	Stan Pyzbylowicz	From:	Shawn McGuinness
Company:	Fairchild Ind. Products Co.	Email:	Smeguinn@itsqs.com
FAX #:	336 659-9356	Date:	December 21, 2000
Pages:	1 (including cover page)	Cc:	
Job #:	J20032031	Model #:	TT800-401/901
Report #:	20032031X	Enclosures	None

Dear Pyzbylowicz

Standards tested: EN61326/EN61000-4-5

The following non-compliances were noted: The units under test all failed their Surge Immunity testing. Failures were manifested on the Line 1 to Neutral portion of the testing at .5KV and or 1KV. Please advise us as to how you wish these units to be shipped back to you for corrective modifications to address the problem

If there's anything I can personally do to be of service please feel free to call me at 678 775-2400. Thank you for your business, we appreciate it. Happy Holidays

This letter report completes the work associated with this job. Please call me if you have any questions or need additional information.

Letter report by:

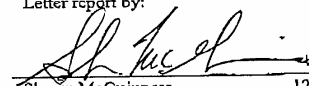
  
 Shawn McGuinness 12/21/00  
 EMC Engineer

Reviewed by:

Jeremy Pickens

  
 Signature 12/21/00



Confidentiality Notice: The information contained in this facsimile transmittal is privileged and confidential. It is intended only for the use of the addressee. If the reader of this message is not the intended recipient, or person responsible to deliver it to the intended recipient, you are hereby notified that any dissemination, distribution or copy of this facsimile transmittal is strictly prohibited. If you have received this transmittal in error, please notify us immediately by telephone and please return the original transmittal to the address above. Thank you.



TA7800-001 Voltage In		Step	Po	Vsurge	Po	Vsurge
	DC P/S Line to Line		14.95			
		1	14.95	+1kV	14.99	-1kV
	044-IPI-134 #1	2	14.95	+1kV	14.99	-1kV
		3	14.95	+1kV	14.99	-1kV
		4	14.95	+1kV	14.99	-1kV
		5	14.99	+1kV	14.99	-1kV
	DC P/S L1, L2/Gnd		14.40			
		1	14.50	+2kV	14.50	-2kV
	Enclosure w/out Z & S	2	14.50	+2kV	14.50	-2kV
	enclosure adjustment screwdrivers	3	14.50	+2kV	14.45	-2kV
		4	14.50	+2kV	14.35	-2kV
		5	14.50	+2kV	14.40	-2kV
	DC P/S L1, L2/Gnd		15.56			
		1	15.54	+2kV	15.57	-2kV
	Added Z & S adjustment	2	15.85	+2kV	15.50	-2kV
	screwdriver bits, complete	3	15.52	+2kV	15.65	-2kV
	enclosure	4	15.56	+2kV	15.53	-2kV
		5	15.62	+2kV	15.53	-2kV
	Signal +Line	Step	Po	Vsurge	Po	Vsurge
			15.55			
		1	15.55	+1kV	15.55	-1kV
		2	15.55	+1kV	15.55	-1kV
		3	15.55	+1kV	15.55	-1kV
		4	15.55	+1kV	15.55	-1kV
		5	15.55	+1kV	15.55	-1kV
	Signal -Line					
		1	15.55	+1kV	15.55	-1kV
		2	15.55	+1kV	15.55	-1kV
		3	15.55	+1kV	15.55	-1kV
		4	15.55	+1kV	15.55	-1kV
		5	15.55	+1kV	15.55	-1kV

# CEMASTER®

Model CM-SURGE

## Surge

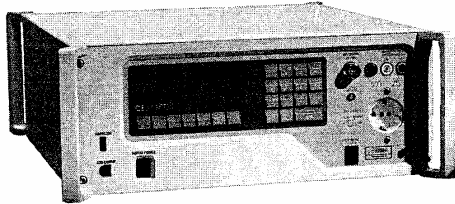

*Provides Surge test capability to IEC 1000-4-5 for the CEMASTER Compliance-Level Immunity Tester.*

### FEATURES

---

- **Provides compliance-level testing** to meet the requirements of the EMC Directive and obtain the CE Mark.
- **Exceeds the maximum test levels** outlined in the Generic Immunity and Product Family Standards for Surge immunity tests.
- **Configurable** with any combination of 5 additional immunity test standards in a single tester.
- **Predefined IEC test routines** from both software and front panel control.
- **Windows® 3.1 and 95 based application software** and/or front panel keypad and graphics display.
- **Includes built-in single phase mains coupler/decoupler** for EUT's to 16A AC and to 10A DC.

### SYSTEM BENEFITS

---

- **Batch IEC test sequences** significantly reduce test throughput times by running entire IEC test sequences in a single pass.
- **Pre-programmed IEC 1000-4-5 test routines** save time and decrease the potential for human error.
- **Automatic compliance report generation, using option CEWare™**, provides Surge test results in a format suitable for archiving CE Mark test records.
- **Light weight, ergonomic design** provides maximum flexibility for operating the CEMASTER from a table top, floor or within a 19-inch rack.
- **Portable architecture** with rugged handles and optional transit case enables users to transport the tester between test departments or to remote facilities.

## Model CM-SURGE

### OUTPUT SPECIFICATIONS AND TOLERANCES

#### ELECTRICAL

<b>Voltage Waveform:</b>	1.2/50 $\mu$ s
<b>Open-Circuit Voltage:</b>	250V to 2.5kV;
<b>Voltage:</b>	1V resolution $\pm$ 10% accuracy
<b>Current Waveform:</b>	8/20 $\mu$ s
<b>Short-Circuit Current:</b>	125A to 1.25kA;
<b>Current:</b>	$\pm$ 10% accuracy
<b>Repetition Rate:</b>	To 6/minute at 500V; slower at higher voltages
<b>Line Sync:</b>	0 to 360°

#### WAVEFORM VERIFICATION

The basic test standards require that the simulator output be verified periodically. The surge open-circuit voltage waveform and peak are verified using differential, high voltage probes. To verify the short-circuit current and its peak, an appropriately rated current transformer is used. The oscilloscope used must be capable of capturing a single pulse and have a bandwidth of >100MHz.

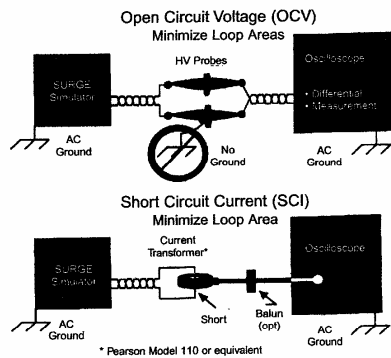

### AN AFFORDABLE EMC IMMUNITY TESTER THAT DOES IT ALL

The CEMASTER® is designed from the ground up to provide compliance-level testing to the standards manufacturers must meet in order to compete in today's international marketplace.

Each CEMASTER is custom configured to meet your specific needs and budget requirements. When completely configured, the CEMASTER provides compliance-level testing to IEC 1000-4-X Series Immunity Standards for:

- IEC 1000-4-2 ESD
- IEC 1000-4-4 EFT
- IEC 1000-4-5 Surge
- IEC 1000-4-8 Power Frequency Magnetic Field
- IEC 1000-4-9 Pulse Magnetic Field
- IEC 1000-4-11 Dips & Interrupts

### AVAILABLE OPTIONS

<b>CM-3CD-16/32:</b>	16 or 32 Amp, 3-phase EFT and Surge coupler/decoupler
<b>CM-I/OCD:</b>	External I/O Signal Lines and telecom line coupler/decoupler with auxiliary clamping protection in accordance with IEC 1000-4-5
<b>CM-I/OCD-HS:</b>	Allows user to bypass the 20mH decoupling chokes specified in IEC 1000-4-5, which will in turn, allow data transfer rates to greater than 100kHz. (Requires CM-I/OCD.)

### CEMASTER PLATFORM (CM-BASE)

#### RATINGS AND POWER REQUIREMENTS

##### Coupler/Decoupler

<b>AC Voltage:</b>	50 to 250V, 50/60Hz
<b>AC Current:</b>	16A continuous
<b>DC Voltage:</b>	0 to 100V
<b>DC Current:</b>	10A continuous
<b>EUT Connectors:</b>	NEMA 5-15, CEE7 ("Schuko") or BS 1363 (British Standard)

#### MINIMUM SYSTEM REQUIREMENTS

##### CM-BASE with CM-SW or CM-FP

#### POWER REQUIREMENTS

<b>Input Voltage:</b>	90-250VAC, 50/60Hz
<b>Input Current:</b>	1A at 120VAC; 0.5A at 240VAC

For additional CEMASTER® literature, call, email or fax the KeyTek sales department.



One Lowell Research Center  
Lowell, Massachusetts 01852-4345 USA  
1 800 753 9835 • Tel: 1 978 275 0800 • Fax: 1 978 275 0850  
email: sales@keytek.com  
http://www.keytek.com

A division of Thermo Voltek, a Thermo Electron company  
KeyTek and CEMASTER are registered trademarks and CEWare is a trademark of Thermo Voltek Corporation. ©Thermo Voltek. Specifications are subject to change without notice. Printed in USA.

KPS-107B-11/97

# CEMASTER®

Model CM-BASE

## Platform

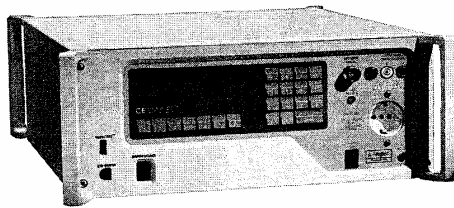

*A customer configured Immunity Tester for compliance testing to:*

*IEC 1000-4-2 ESD*

*IEC 1000-4-4 EFT*

*IEC 1000-4-5 Surge*

*IEC 1000-4-8 Power Frequency  
Magnetic Field*

*IEC 1000-4-9 Pulse Magnetic Field*

*IEC 1000-4-11 Dips & Interrupts.*

### FEATURES

- A cost-effective, compliance-level tester to be used as a primary test station, or to augment other test capabilities and stations in large facilities.
- Customer configurable Immunity Tester provides from one to six immunity tests in a single unit.
- Windows® 3.1 and 95 based application software and/or front panel keypad and graphics display.
- Pre-programmed IEC test routines from both software and front panel control.
- Portable, light weight design.
- Optional transport case.
- Optional 19" rack mount kit.

### SYSTEM BENEFITS

- Low cost, multi-standard test system provides manufacturers with a single, stand-alone system solution.
- Light weight, ergonomic design provides maximum flexibility for operating the CEMASTER from a table top or within a 19-inch rack.
- Portable architecture with rugged handles and optional transit case enables users to transport the tester between test departments or remote facilities.
- Automatic compliance report generation, using option CEWare™, provides test results in a format suitable for archiving CE Mark test records.

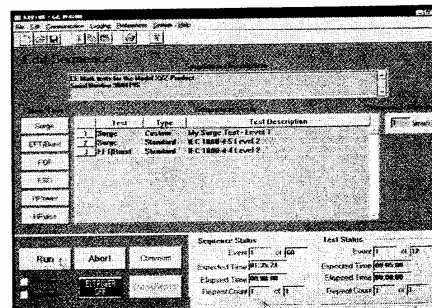

Typical Software Screen Operating under Windows®

## Model CM-BASE

### SPECIFICATIONS AND TOLERANCES

#### CEMASTER IMMUNITY TEST LEVELS

<b>IEC 1000-4-2</b>	500V - 8.8kV Air Discharge 500V - 4.4kV Contact Mode
<b>IEC 1000-4-4</b>	250V - 2.5kV; 1- 100kHz
<b>IEC 1000-4-5</b>	250V - 2.5kV; 125A - 1.25kA
<b>IEC 1000-4-8</b>	0.5 - 4A/m AC H-Field
<b>IEC 1000-4-9</b>	50 - 800A/m Pulse Field
<b>IEC 1000-4-11</b>	100, 70, 40 and 0% short or open; inrush >250A @ 120V, and >500A @ 240V

#### RATINGS AND POWER REQUIREMENTS

##### Coupler/Decoupler

<b>AC Voltage:</b>	50 to 250V, 50/60Hz
<b>AC Current:</b>	16A continuous
<b>DC Voltage:</b>	0 to 100V
<b>DC Current:</b>	10A continuous
<b>EUT Connectors:</b>	NEMA 5-15, CEE7 ("Schuko"), or BS 1363 (British Standard)

#### POWER REQUIREMENTS

<b>Input Voltage:</b>	90-250VAC, 50/60Hz
<b>Input Current:</b>	1A at 120VAC; 0.5A at 240VAC

#### PHYSICAL

<b>Height:</b>	17.8cm (7")
<b>Width:</b>	47cm (18.5")
<b>Depth:</b>	56cm (22")
<b>Weight:</b>	29kg (64 lbs.)

#### ENVIRONMENTAL

##### Operating Limits

<b>Temperature:</b>	15 - 40°C
<b>Humidity:</b>	10 - 75%, non-condensing
<b>Altitude:</b>	8000 feet max.

##### Storage Limits

<b>Temperature:</b>	0 - 60°C
<b>Humidity:</b>	10 - 90%, non-condensing
<b>Altitude:</b>	8000 feet max.

#### MINIMUM SYSTEM REQUIREMENTS

**CM-BASE with CM-SW or  
CM-FP and at least one immunity test capability**

### AVAILABLE OPTIONS

#### IMMUNITY TEST CAPABILITIES

<b>CM-ESD:</b>	Electrostatic Discharge (IEC 1000-4-2)
<b>CM-EFT:</b>	Electrical Fast Transient (IEC 1000-4-4)
<b>CM-SURGE:</b>	Surge (IEC 1000-4-5)
<b>CM-HPWR:</b>	Power Frequency Magnetic Field (IEC 1000-4-8)
<b>CM-HPULSE:</b>	Pulse Magnetic Field (IEC 1000-4-9)
<b>CM-PQF:</b>	Dips and Interrupts (IEC 1000-4-11)

#### CONTROL FUNCTIONS

<b>CM-SW:</b>	Windows® based application software (CEWare™) provides the ability to run any sequence of predefined IEC routines or user defined immunity tests. User must purchase either CM-SW, CM-FP or both.
<b>CM-FP:</b>	Front Panel keypad and graphics display for manual operation or automatic control using predefined IEC routines. User must purchase either CM-SW, CM-FP or both.
<b>CM-SW/FP:</b>	Combines both software (CM-SW) and front panel (CM-FP) control functions.

#### OTHER

<b>CM-RMK:</b>	19" Rack Mount Kit
<b>CM-CASE:</b>	Transportation case for the CEMASTER and accessories

*For additional CEMASTER® literature, call, email or  
fax the KeyTek sales department.*



One Lowell Research Center  
Lowell, Massachusetts 01852-4345 USA  
1 800 753 9835 • Tel: 1 978 275 0800 • Fax: 1 978 275 0850  
email: sales@keytek.com  
http://www.keytek.com

A division of Thermo Volttek, a Thermo Electron company  
KeyTek and CEMASTER are registered trademarks and CEWare is a trademark of  
Thermo Volttek Corporation. ©Thermo Volttek. Specifications are subject to change  
without notice. Printed in USA.

KPS-653C-11/97



Transient Specialists, Inc.

Rugeley Road  
Western Springs, IL 60558  
708.246.3297

INVOICE  
for  
Equipment Rental

**Invoice # :I2781**  
Customer P.O. # 1-3281  
Invoice date 04/02/2001  
Payment Terms :Net 30

**Sold To:**

Fairchild Ind. Products  
Accounts Payable  
3920 West Point BLVD  
Winston-Salem, NC 27103

**Ship To:**

Fairchild Ind. Products  
Accounts Payable  
3920 West Point BLVD  
Winston-Salem, NC 27103  
Attn: Stan Przybylowicz  
Ph: 336 659 3400

Customer #	Representative	Rep. Fax No.	Shipped Via	Shipping Terms
C1471	Teqspec Inc.	(321) 784-0992	Federal Express	See Agreement

Qty	Rental Period	Part Number	Description	Price Per Period	Item Total
1	1 Mo.	CM-IOCD	Rental for the period starting 04/03/2001 and ending 05/02/2001	\$600.00	\$600.00

<b>and Total</b>	\$600.00
------------------	----------

## T7800 Overview of EMC Directive Requirements

### EMC Directives review:

1. Directive 2004/108/EC replaces 89/336/EEC
2. Transitional provisions - Member States shall not impede the placing on the market and/or the putting into service of equipment which is in compliance with the provisions of Directive 89/336/EEC and which was placed on the market before 20 July 2009
3. Directive 2004/108/EC location:  
<http://eurlex.europa.eu/LexUriServ/LexUriServ.do?uri=CELEX:32004L0108:EN:HTML>
4. EN61326 +A1, A2, A3 & reaffirmed 01/05 – this is still the relevant equipment category standard: Electrical Equipment for Measurement, Control and Laboratory use. It specifies the tests and standards for the various types of EMC immunity and emissions requirements.

### EN 61326: Electrical Equipment for Measurement, Control and Lab Use

1. Equipment shall not become dangerous or unsafe as a result of the application of the tests
  - a. Testing only
  - b. Does this pertain to final installations? If so, it is beyond our scope – installer responsibility
  - c. Specs required identify performance criteria. ‘A’ is preferred, although ‘B’ is found in some of FIPC products such as per the Surges testing. Performance criteria definitions indicated on P. 3.
2. Table 2, EN 61326 – Example of evaluation of Immunity test results - Additional column added – Essential operation (functional safety) – must be readily available to end users.
3. Table A.1, Note g, EN 61326: DC connections between parts of equipment/system which are not connected to a d.c. distribution network are treated as I/O signal/control ports. Class A Equipment – non-domestic (industrial)

T7800 Test requirements

EN 61326:1997 + A1, A2, A3, REAFF '05  
 Table A.1 – Immunity Test Reqs – Industrial locations – T7800 – Class A Equipment – non-domestic

Ports	Phenomenon	Basic Std	Test Value	Performance Criteria
Immunity Enclosure	Electrostatic Discharge (ESD)	IEC 61000-4-2	4 kV/8 kV contact/air (Level 2/3)	A
	EM Field	IEC 61000-4-3	10 V/m	A
	Rated Power Frequency magnetic field	IEC 61000-4-8	30 A/m (Level 4)	A
AC Power – N/A T7800	Voltage Dip/short interruptions	IEC 61000-4-11	0.5 cycle, each polarity/100%	N/A
	Burst	IEC 61000-4-4	2 kV	
	Surge	IEC 61000-4-5	1 kV/2 kV	
	Conducted RF	IEC 61000-4-6	3 V	
	Burst	IEC 61000-4-4	2 kV	A
	Surge	IEC 61000-4-5	1 kV/2 kV	B
DC Power T7800	Conducted RF	IEC 61000-4-6	3 V	A
	Burst	IEC 61000-4-4	2 kV	A
	Surge	IEC 61000-4-5	1 kV/2 kV	B
I/O Signal/Control	Conducted RF	IEC 61000-4-6	3 V	A
	Burst	IEC 61000-4-4	2 kV	N/A
	Surge	IEC 61000-4-5	1 kV/2 kV	N/A
I/O Signal/Control connected directly to power supply network - DC Power – N/A T7800	Conducted RF	IEC 61000-4-6	3 V	
	Burst	IEC 61000-4-4	2 kV	
	Surge	IEC 61000-4-5	1 kV/2 kV	

Performance Criteria – letters in parentheses indicate possible lower performance level.

Table 3 – Emission limits for Class A Equipment

Emissions Class A Equip	Basic Standard – ISM Frequencies	Frequency Range - MHz	Limits	Ref Standard
Enclosure	CISPR 11:1990 (EN 55011:1998)	30 – 230	40db (uV/m) quasi peak, measured at 10 m distance	CISPR 16-1 CISPR 16-2
Enclosure	CISPR 11:1990 (EN 55011:1998)	230 - 1000	47db (uV/m) quasi peak, measured at 10 m distance	CISPR 16-1 CISPR 16-2
AC Mains N/A	N/A	N/A	N/A	N/A

Performance Criteria definitions:

- A During testing, normal performance within spec limits.
- B During testing, temporary degradation, or loss of function or performance which is self-recovering.
- C During testing, temporary degradation, or loss of function or performance which requires operator intervention or system reset occurs.
- D Degradation or loss of function which is not recoverable due to damage to equipment, components, software, or to loss of data.

**Standards:**

**Immunity**

Standard – in house	Dated	Standard – new	Dated	Required to Order
EN 61000-4-2	1995	IEC 61000-4-2	04/01	06/12/07
EN 61000-4-3	1997	IEC 61000-4-3	02/06	06/12/07
IEC 1000-4-4	1995	IEC 61000-4-4	08/06	06/12/07
EN 61000-4-5	1995 (1996 Amm.)	IEC 61000-4-5	11/05	06/12/07
EN 61000-4-6	1996	IEC 61000-4-6	05/06	06/12/07
EN 61000-4-8	1993	IEC 61000-4-8	03/01	06/12/07

**Emission**

Standard – in house	Dated	Standard – new	Dated	Order
CISPR 11:1990 (EN 55011:1998)	1998	CISPR 11:1990	1990	N/A

# ITS Intertek Testing Services

Originator's Report Number: 0032025t-002.doc

Job Number: J20032025

May 2, 2001

**Evaluation of the**  
**Electro to Pneumatic Transducers**  
Models: TT7800-401, TD7800-401, TT7800-901 and TD7800-901

to

**EN 61326: 1997 +A1: 1998**

For

**Fairchild Industrial Product Company**

Date of Test: November 20 and 22, and December 20, 2000

Testing performed by:  
Intertek Testing Services  
1950 Evergreen Blvd., Suite 100  
Duluth, Georgia 30096

Testing Authorized by:  
Fairchild Industrial Product Company  
3920 Westpoint Blvd.  
Winston-Salem, N.C. 27102

Prepared by:

  
Shawn McGuinness

Date:

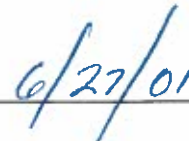
  
6/27/01

Reviewed by:

  
David Schramm

Date:

  
6/27/01

*All services undertaken are subject to the following general policy: Reports are submitted for exclusive use of the client to whom they are addressed. Their significance is subject to the adequacy and representative character of the samples and to the comprehensiveness of the tests, examinations or surveys made. This report shall not be reproduced except in full, without written consent of Intertek Testing Services NA Inc. This report must not be used to claim product endorsement by NVLAP, NIST nor any other agency of the U.S. Government.*

# Intertek Testing Services

## TABLE OF CONTENTS

<b>EXECUTIVE SUMMARY</b> .....	4
<b>1.0 INTRODUCTION</b> .....	5
1.1 SCOPE.....	5
1.2 PURPOSE .....	5
1.3 BRIEF DESCRIPTION OF EUT AND RECEIVED CONDITION .....	5
1.4 SYSTEM TEST CONFIGURATION.....	6
1.5 SYSTEM BLOCK DIAGRAM .....	7
1.6 EUT OPERATION AND EXERCISE.....	8
1.7 JUSTIFICATIONS.....	8
1.8 MODIFICATIONS REQUIRED FOR COMPLIANCE.....	8
<b>2.0 TEST ENVIRONMENT</b> .....	9
2.1 TEST FACILITY.....	9
2.2 TEST EQUIPMENT .....	9
2.3 PERFORMANCE CRITERIA.....	9
2.4 FIELD STRENGTH CALCULATION.....	10
TABLE 2.1 TEST EQUIPMENT.....	11
<b>3.0 IEC 61000-4-2, ELECTROSTATIC DISCHARGE IMMUNITY</b> .....	12
3.1 TEST DESCRIPTION.....	12
3.2 TEST PROCEDURE.....	12
3.3 TEST RESULTS.....	12
3.4 TEST CONFIGURATION PHOTOGRAPH.....	12
<b>4.0 IEC 61000-4-3, RADIATED RF ELECTROMAGNETIC FIELD IMMUNITY</b> .....	14
4.1 TEST DESCRIPTION.....	14
4.2 TEST PROCEDURES.....	14
4.3 TEST RESULTS.....	14
4.4 TEST CONFIGURATION PHOTOGRAPH.....	14
<b>5.0 IEC 61000-4-4, ELECTRICAL FAST TRANSIENTS/BURSTS IMMUNITY</b> .....	16
5.1 TEST DESCRIPTION.....	16
5.2 TEST PROCEDURE.....	16
5.3 TEST RESULTS.....	16
5.4 TEST CONFIGURATION PHOTOGRAPH.....	16
<b>6.0 IEC 61000-4-5, SURGE IMMUNITY</b> .....	19
6.1 TEST DESCRIPTION.....	19
6.2 TEST PROCEDURE.....	19
6.3 TEST RESULTS.....	19
6.4 TEST CONFIGURATION PHOTOGRAPH.....	19
<b>7.0 IEC 61000-4-6, CONDUCTED RF INTERFERENCE IMMUNITY</b> .....	21
7.1 TEST DESCRIPTION.....	21
7.2 TEST PROCEDURE.....	21
7.3 TEST RESULTS.....	21
7.4 TEST CONFIGURATION PHOTOGRAPH.....	21
<b>8.0 IEC 61000-4-8, POWER FREQUENCY MAGNETIC FIELDS</b> .....	24
8.1 TEST DESCRIPTION.....	24
8.2 TEST PROCEDURE.....	24
8.3 TEST RESULTS.....	24
8.4 TEST CONFIGURATION PHOTOGRAPH.....	24

# Intertek Testing Services

---

<b>9.0</b>	<b>IEC 61000-4-11, VOLTAGE DIPS AND VOLTAGE INTERRUPTIONS.....</b>	<b>26</b>
9.1	TEST DESCRIPTION.....	26
9.2	TEST PROCEDURE.....	26
9.3	TEST RESULTS.....	26
9.4	TEST CONFIGURATION PHOTOGRAPH.....	26
<b>10.0</b>	<b>ELECTROMAGNETIC RADIATION DISTURBANCE .....</b>	<b>28</b>
10.1	TEST DESCRIPTION.....	28
10.2	TEST PROCEDURE .....	29
10.3	TEST RESULTS.....	29
10.4	TEST CONFIGURATION PHOTOGRAPH.....	29
	Table 10.1: Radiated Disturbance.....	30
<b>11.0</b>	<b>AC MAINS LINE-CONDUCTED DISTURBANCE .....</b>	<b>33</b>
11.1	TEST DESCRIPTION.....	33
11.2	TEST PROCEDURE .....	34
11.3	TEST RESULTS.....	34
11.4	TEST CONFIGURATION PHOTOGRAPHS.....	34
	Table 11.1: Conducted Disturbance.....	35
<b>12.0</b>	<b>EN 61000-3-2, HARMONIC CURRENTS .....</b>	<b>38</b>
12.1	TEST DESCRIPTION.....	38
12.2	TEST PROCEDURE .....	38
12.3	TEST RESULTS.....	38
	NOTE: THIS TEST NOT UNDER THE SCOPE OF THE EVALUATION	
	<b>ERROR! BOOKMARK NOT DEFINED.</b>	
13.0	EN 61000-3-3, VOLTAGE FLUCTUATIONS AND FLICKER.....	39
13.1	TEST DESCRIPTION.....	39
13.2	TEST PROCEDURE .....	39
13.3	TEST RESULTS.....	39



# Intertek Testing Services

## EXECUTIVE SUMMARY

Fairchild Industrial Product Company

Equipment Under Test: Electro to Pneumatic Transducers,  
Models: TT7800-401, TD7800-401, TT7800-901 and TD7800-901

Equipment type or intended environment: Industrial Environment

Functional Aspect: Continuous Unmonitored

Test Description	Performance Criteria	Comments
EN 61326 / CISPR 16 and CISPR 16-1 Radiated Emissions	Class A	Pass
EN 61326 / CISPR 16 and CISPR 16-1 Conducted Emissions	N/A	N/A <sup>1</sup>
IEC 61000-3-2 Power Frequency Harmonic Currents	N/A	N/A
IEC 61000-3-3 Voltage Fluctuation	N/A	N/A
IEC 61000-4-2 Immunity to ESD	B	N/S <sup>2</sup>
IEC 61000-4-3 Immunity to radiated RF fields	A	Pass
IEC 61000-4-4 Immunity to electrical fast transients	B	N/S
IEC 61000-4-5 Immunity to surges	B	N/S
IEC 61000-4-6 Immunity to conducted RF	A	N/S
IEC 61000-4-8 Immunity to power frequency magnetic fields	A	N/S
IEC 61000-4-11 Immunity to voltage dips and interruptions	B	N/A

See section 1.8 for modifications required for compliance.

<sup>1</sup> N/A denotes that the test was not applicable because the EUT does not connect to the AC mains

<sup>2</sup> N/S denotes that the test was not under the scope of the evaluation

## **1.0 INTRODUCTION**

### **1.1 Scope**

This report is designed to show compliance with the European Standard EN 61326: 1997 with Amendment 1: 1998, Electrical equipment for measurement, control and laboratory use. The test procedures described in EN 61326 were employed. A description of the product and operating configuration, the various provisions of the rules, the methods of determining compliance and a detailed summary of the results are included within this test report.

### **1.2 Purpose**

Testing was performed to evaluate the Electro to Pneumatic Transducers, Model: TT7800-401, TD7800-401, TT7800-901 and TD7800-901 for immunity and emissions requirements regarding electromagnetic compatibility in accordance with EN61326.

### **1.3 Brief Description of EUT and Received Condition**

The EUT are electric signal to pneumatic converters.

A Pre-Production version of the sample was received on November 20, 2000 in good condition.

# Intertek Testing Services

## 1.4 System Test Configuration

Equipment Under Test			
Make / Description	Model Numbers	Serial Number	FCC ID
Electro to Pneumatic Transducers	TT7800-401, TD7800-401, TT7800-901 and TD7800-901	Not Labeled	Not Labeled

Support Equipment			
Description	Manufacturer	Model Number	Serial Number
Air Regulator	Fairchild	M10	102262
Analog Gauges	Heise	CMM16273/CMM16272	Not Labeled
20 MA Signal Analyzer	Fairchild	ET234	Not Labeled

Cables					
Quantity	Type	Length	Shielding	Ferrites	Connection
2	Shielded Twisted Pair	20 ft.	Shielded	No	Wire

# Intertek Testing Services

## 1.5 System Block Diagram

The diagrams shown below details the placement of the equipment under test on the table.

FIGURE 2

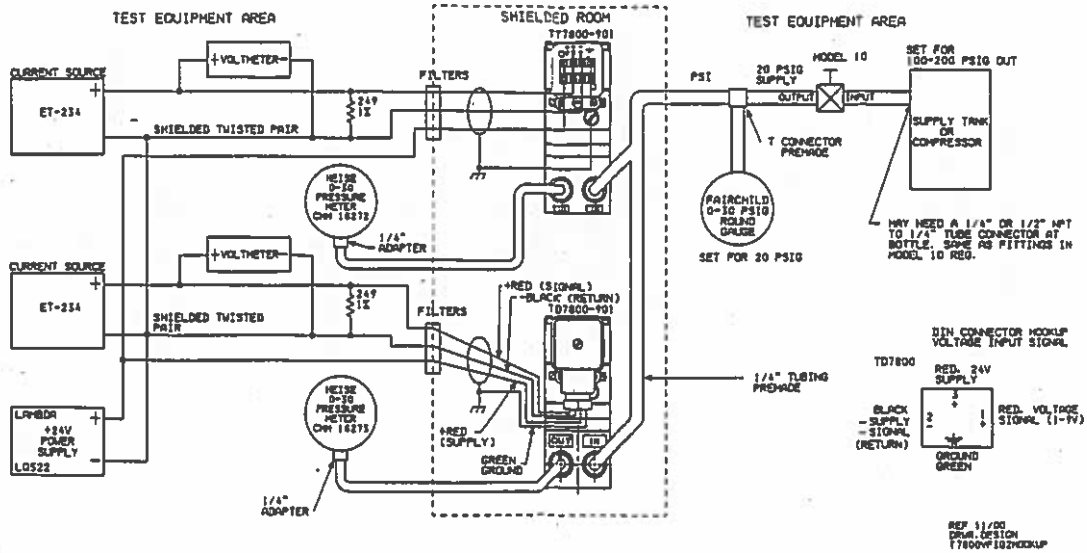
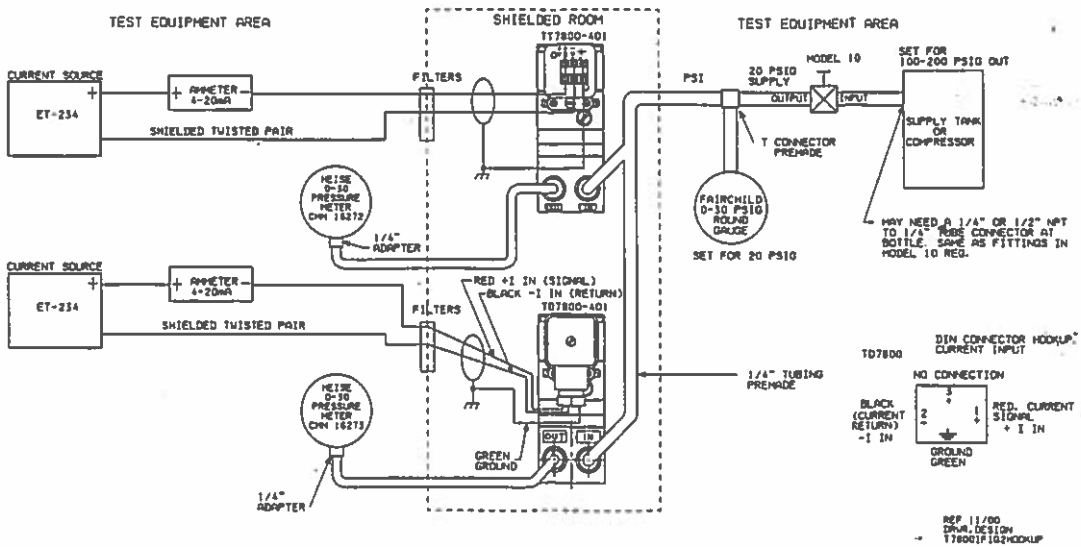

FIGURE 2



## Intertek Testing Services

---

### **1.6 EUT Operation and Exercise**

The EUT exercise program used during radiated and conducted testing was designed to exercise the various system components in a manner similar to a typical use. The system was pressurized to a constant pressure of 20 PSIG. A 4-20 mA signal was supplied to the EUT, which regulated the pressure out to 18 PSIG. Two Heise analog pressure meters were used to monitor the regulated output of the EUT. If the pressure fluctuated more than 1 PSIG, the system was considered operating outside normal tolerance.

### **1.7 Justifications**

The system was configured for testing in a typical fashion (as a customer would normally use it). During testing, all cables were manipulated to produce worst case emissions.

The arrangement of the cables dangling from the rear of the table was varied to the extent possible to produce the maximum emissions.

To insure maximum emissions were detected, the system was rotated 360 degrees, the antenna height was varied from 1 to 4 meters above the ground plane in both horizontal and vertical polarizations. These maximum emissions are represented in Section 3.0.

### **1.8 Modifications Required for Compliance**

No modifications were installed during compliance testing in order to bring the product into compliance (Please note that this list does not include changes made specifically by Fairchild Industrial Product Company prior to compliance testing).

# Intertek Testing Services

## 2.0 TEST ENVIRONMENT

### 2.1 Test Facility

The Duluth 10-meter chamber site is located at 1950 Evergreen Blvd., Suite 100, Duluth, Georgia. The test site is a 10-meter semi-anechoic chamber. The site meets the characteristics of CISPR 16-1: 1993 and ANSI C63.4: 1992. For measurements a remotely controlled flush-mount metal-top turntable is used to rotate the EUT a full 360 degrees. A remote controlled non-conductive antenna mast is used to scan the antenna height from one to four meters.

### 2.2 Test Equipment

Table 2.1 contains a list of the test equipment used during the testing.

### 2.3 Performance Criteria

Performance criterion A: During testing normal performance within the specification limits.

Performance criterion B: During testing, temporary degradation, of loss of function or performance that is self-recovering.

Performance criterion C: During testing, temporary degradation, or loss function or performance which requires operator intervention or system reset occurs

Performance criterion D: Degradation or loss of function that is not recoverable due to damage to equipment, components, software, or to loss of data.

The compliance criteria are selected based on the functional aspects of the equipment under test (EUT) per Section 6 of EN 61326. Selection was based on the following matrix:

Test	Essential Operation (functional safety)	Continuous Unmonitored Operation	Continuous Monitored Operation	Non-continuous Operation
IEC 61000-4-2	A	B	B	C
IEC 61000-4-3	A	A	A	B
IEC 61000-4-4	A	B	B	B
IEC 61000-4-5	A	B	B	C
IEC 61000-4-6	A	A	A	C
IEC 61000-4-8	A	A	A	B
IEC 61000-4-11	A	B	C	C

### 2.4 Field Strength Calculation

The field strength is calculated by adding the Antenna Factor and Cable Factor, and subtracting the Amplifier Gain (if any) from the measured reading. The basic equation with a sample calculation is as follows:

$$FS = RA + AF + CF - PA$$

Where

- FS = Field Strength in dB( $\mu$ V/m)
- RA = Receiver Amplitude (including preamplifier) in dB( $\mu$ V)
- CF = Cable Attenuation Factor in dB
- AF = Antenna Factor in dB(1/m)
- PA = Preamplifier Factor in dB

Assume a receiver reading of 52.0 dB( $\mu$ V) is obtained. The antenna factor of 7.4 dB and cable factor of 1.6 dB is added. The amplifier gain of 29 dB is subtracted, giving a field strength of 32 dB( $\mu$ V/m).

$$\begin{aligned} RA &= 52.0 \text{ dB}(\mu\text{V}) \\ AF &= 7.4 \text{ dB}(1/\text{m}) \\ CF &= 1.6 \text{ dB} \\ PA &= 29.0 \text{ dB} \\ FS &= RF + AF + CF - PA \\ FS &= 52.0 + 7.4 + 1.6 - 29.0 \\ FS &= 32 \text{ dB}(\mu\text{V}/\text{m}) \end{aligned}$$

## Intertek Testing Services

---

**Table 2.1 Test Equipment**

Description	Manufacturer	Model Number	Serial Number	Cal Date
Amplifier, Wideband RF Power	IFI	CMX-5001	A777-1297	N/A
Amplifier, Wideband RF Power	Kalmus	747LC-CE	7715-1	N/A
Antenna, BiConiLog	EMCO	3141	9711-1080	3/3/2000
Antenna, Biconlog	EMCO	3143	9404-1031	N/A
Antenna, BiLog	Chase	CBL6112A	2245	11/9/2000
EMI Receiver	Hewlett Packard	8546A	3410A00173	3/17/2000
Field Monitor	Amplifier Research	FM2000	13326	N/A
Field Probe	Amplifier Research	FP2000	13211	11/14/2000
Preselector	Hewlett Packard	85460A	3348A00203	3/17/2000
Signal Generator	Fluke	6082A	5330802	4/10/2000



# Intertek Testing Services

---

## 3.0 IEC 61000-4-2, ELECTROSTATIC DISCHARGE IMMUNITY

### 3.1 Test Description

CENELEC Publication 61000-4-2:1995, Electromagnetic Compatibility, Part 4: Testing and Measurement Techniques – Section 2: Electrostatic Discharge Immunity Test, Basic EMC Publication was the guiding document for this test. This test evaluates the test sample's response to electrostatic discharge events that occur to the body of the test sample discharged through air and by contact discharge.

**Table 3.1-1: ESD levels for different equipment types**

Standard environment		Industrial Environment		Controlled EM Environment		Portable Equipment	
Air	Contact	Air	Contact	Air	Contact	Air	Contact
±4 kV	±4 kV	±8 kV	±4 kV	±8 kV	±4 kV	±8 kV	±4 kV

### 3.2 Test Procedure

The electrostatic discharge test level is set and discharges are applied to the conductive surface under the test sample, the conductive surface vertical to the test sample, and along all seams and control surfaces on the test sample. If a discharge occurs and an error is caused, the type of error, discharge level and location is recorded.

### 3.3 Test Results

**Note:** This test was not under scope of evaluation.

### 3.4 Test Configuration Photograph

Figure 3.1 shows the testing configuration used.

(THIS PAGE INTENTIONALLY LEFT BLANK)

*Figure 3.1 Test Configuration Photograph*

**4.0 IEC 61000-4-3, RADIATED RF ELECTROMAGNETIC FIELD IMMUNITY**

**4.1 Test Description**

CENELEC Publication 61000-4-3:1995, Electromagnetic Compatibility, Basic Immunity Standard for radiated, radio frequency electromagnetic field immunity, was the guiding document for this test. This test evaluates the test sample's response to radiated electric fields and was performed from 80 to 1000 MHz and from 1.4 to 2.0 GHz at a level of 1, 3 or 10 V/m, 80% Amplitude Modulated w/1 kHz sinewave.

**Table 4.1-1: Radiated RF levels for different equipment types**

Standard environment	Industrial Environment	Controlled EM Environment	Portable Equipment
3 V/m	10 V/m	1 V/m	3 V/m

**4.2 Test Procedures**

The test sample was set into operation and monitored for variations in performance. The test signal was set for frequency, modulation level, and field strength. The procedure was performed, by adjusting the transmitting antenna, so that the electromagnetic field was vertically polarized while sweeping through the appropriate frequency range, and maintaining the necessary field strength. This procedure was then repeated with the transmitting antenna adjusted to the horizontal polarization position. The test was performed with the antenna facing each side of the EUT. If an error were detected, the field strength would be reduced until the error corrects, then increased until the error begins to occur. This threshold level, the frequency and the error created are noted before continuing.

**4.3 Test Results**

The Equipment Under Test was evaluated to the Industrial Environment requirements and test levels of this standard.

The Equipment Under Test was found immune to swept radio-frequency electromagnetic field at the appropriate field strength when tested as received.

**4.4 Test Configuration Photograph**

Figure 4.1 shows the testing configuration used.

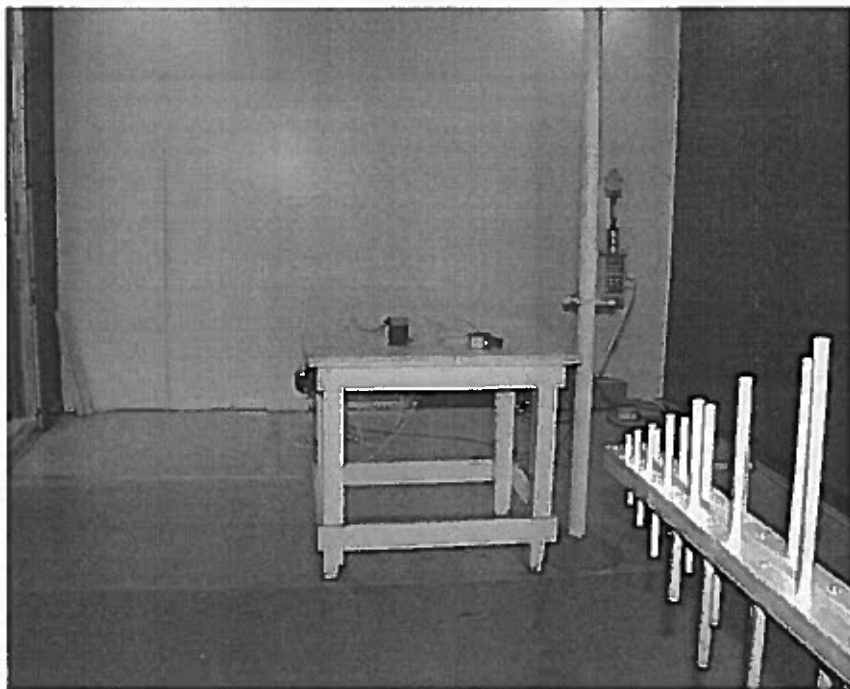

*Figure 4.1 Test Configuration Photograph*

## 5.0 IEC 61000-4-4, ELECTRICAL FAST TRANSIENTS/BURSTS IMMUNITY

### 5.1 Test Description

CENELEC Publication 61000-4-4:1995, Electromagnetic Compatibility, Part 4: Testing and Measurement Techniques – Section 4: Electrical Fast Transient/Burst Immunity Test was the guiding document for this test. This test evaluates the test sample's response to burst interference transients conducted on the power supply lines and I/O signal lines to the EUT. The test levels are specified in Table 5.1-1.

**Table 5.1-1: EFT/Burst levels for different equipment types**

	Standard environment	Industrial Environment	Controlled EM Environment	Portable Equipment
AC Power	1 kV	2 kV	1 kV	N/A
DC Power	1 kV	2 kV	1 kV	N/A
I/O signal/control	0.5 kV <sup>(1)</sup>	1 kV <sup>(1)</sup>	0.5 kV <sup>(1)</sup>	N/A
I/O signal/control connected directly to mains supply	1 kV	1 kV	N/A	N/A
Measurement I/O	N/A	N/A	X <sup>(2)</sup>	N/A

(1) Only in the case of lines > 3m

(2) The rated disturbance values shall be stated in the product specification by the manufacturer.

### 5.2 Test Procedure

The test sample was connected to the test equipment, as shown in Figure 5.1, and monitored for performance. The transients were directly injected onto the DC power input lines or Mains supply lines to the test sample. Using a capacitive coupling clamp as called out in IEC 61000-4-4, the transients were capacitively coupled onto I/O and process control lines to the test sample. This test configuration is shown in Figure 5.2. This coupling clamp provides the ability of coupling the fast transients/bursts to the circuit under test without any galvanic connection to the terminals of the circuits, shielding of the cables or any other part of the EUT. The equipment was monitored during testing for any degradation in performance. When an error or any degradation occurs, the test level is reduced until the condition corrects and then increased until the immunity threshold is reached. This threshold level and the error conditions are noted before continuing.

### 5.3 Test Results

**Note:** This test was not under scope of the evaluation.

### 5.4 Test Configuration Photograph

Figures 5.1 and 5.2 show the testing configurations used.

(THIS PAGE INTENTIONALLY LEFT BLANK)

*Figure 5.1 Test Configuration Photograph*

(THIS PAGE INTENTIONALLY LEFT BLANK)

*Figure 5.2 Test Configuration Photograph*

# Intertek Testing Services

## 6.0 IEC 61000-4-5, SURGE IMMUNITY

### 6.1 Test Description

CENELEC Publication 61000-4-5:1995, Electromagnetic Compatibility – Basic Immunity Standard – Surge Immunity Tests was the guiding document for this test. This test evaluates the test sample's response to surges caused by overvoltages from switching and lightning transients on power supply and I/O lines. A Combination Wave (Hybrid) Generator (1.2/50  $\mu$ sec-8/20  $\mu$ sec) is used with coupling/decoupling networks.

**Table 6.1-1: Surge levels for different equipment types**

	Standard environment	Industrial Environment	Controlled EM Environment	Portable Equipment
AC Power	0.5 kV <sup>(1)</sup> 1 kV <sup>(2)</sup>	1 kV <sup>(1)</sup> 2 kV <sup>(2)</sup>	0.5 kV <sup>(1)</sup> 1 kV <sup>(2)</sup>	N/A
DC Power	0.5 kV <sup>(1)</sup> 1 kV <sup>(2)</sup>	1 kV <sup>(1)</sup> 2 kV <sup>(2)</sup>	Not required	N/A
I/O signal/control	1 kV <sup>(2)(3)</sup>	1 kV <sup>(2)(3)</sup>	Not required	N/A
I/O signal/control connected directly to mains supply	0.5 kV <sup>(1)</sup> 1 kV <sup>(2)</sup>	1 kV <sup>(1)</sup> 2 kV <sup>(2)</sup>	Not required	N/A
Measurement I/O	N/A	N/A	Not required	N/A

(1) Line to line

(2) Line to earth (ground)

(3) Only in the case of long distance lines

### 6.2 Test Procedure

The test sample was connected to the test equipment, as shown in Figure 6.1, and monitored for performance. The test was computer controlled. For differential mode testing, surges were applied line to line in both positive and negative polarities. For common mode testing, surges were applied line to ground in both positive and negative polarities. For application to the AC Mains, the surge generator was set to trigger at the zero crossing, 90, and 270 degrees with respect to the AC supply voltage waveform.

### 6.3 Test Results

This test was not under the scope of the evaluation.

### 6.4 Test Configuration Photograph

Figure 6.1 shows the testing configuration used.



(THIS PAGE INTENTIONALLY LEFT BLANK)

*Figure 6.1 Test Configuration Photograph*

## Intertek Testing Services

### 7.0 IEC 61000-4-6, CONDUCTED RF INTERFERENCE IMMUNITY

#### 7.1 Test Description

CENELEC Publication 61000-4-6:1996, Electromagnetic Compatibility – Basic immunity standard – Conducted disturbances induced by radio frequency fields was the guiding document for this test. This test evaluates the test sample's response to conducted RF disturbances on Mains supply lines and signal I/O lines.

**Table 7.1-1: Conducted RF levels for different equipment types**

	Standard environment	Industrial Environment	Controlled EM Environment	Portable Equipment
AC Power	3 V	3 V	1 V	N/A
DC Power	3 V	3 V	1 V	N/A
I/O signal/control	3 V <sup>(1)</sup>	3 V <sup>(1)</sup>	1 V <sup>(1)</sup>	N/A
I/O signal/control connected directly to mains supply	3 V	3 V	N/A	N/A
Measurement I/O	N/A	N/A	X <sup>(2)</sup>	N/A

(1) Only in the case of lines > 3m

(2) The rated disturbance values shall be stated in the product specification by the manufacturer.

#### 7.2 Test Procedure

The test sample was connected to the test equipment, as shown in Figure 7.1, and monitored for performance. A coupling/decoupling network, or EM Clamp, was used to inject the RF interference onto each of the Mains supply lines and signal I/O lines. The RF signal continuously sweeps the frequencies from 150 kHz to 80 MHz with a 1 kHz sinewave amplitude modulated 80%.

#### 7.3 Test Results

**Note:** This test was not under scope of the evaluation.

#### 7.4 Test Configuration Photograph

Figures 7.1 and 7.2 show the testing configurations used.

(This page intentionally left blank)

*Figure 7.1 Test Configuration Photograph*

**(THIS PAGE INTENTIONALLY LEFT BLANK)**

*Figure 7.2 Test Configuration Photograph*

# Intertek Testing Services

---

## 8.0 IEC 61000-4-8, POWER FREQUENCY MAGNETIC FIELDS

### 8.1 Test Description

CENELEC Publication EN61000-4-8:1993, Electromagnetic Compatibility Part 4: Testing and Measurement Techniques Section 8: Power Frequency Magnetic Field Immunity Test was the guiding document for this test. This test evaluates the test sample's response to power frequency magnetic disturbances.

**Table 8.1-1: Magnetic field levels for different equipment types**

	Standard environment	Industrial Environment	Controlled EM Environment	Portable Equipment
Enclosure	N/A	30 A/m <sup>(1)</sup>	N/A	N/A

(1) Only to magnetically sensitive equipment. CRT interference is allowed above 1 A/m.

### 8.2 Test Procedure

The test sample was connected to the test equipment, as shown in Figure 8.1, and monitored for performance. A standard square induction coil (1-meter side) as called out in EN61000-4-8 was used to apply a magnetic field to the test sample using the immersion method. The induction coil was positioned in three separate orthogonal positions for application of the magnetic field around the EUT. The power source was set to 50 Hz and voltage was applied to the induction coil until the magnetic field strength at the equipment under test reached the appropriate level. The magnetic field was applied to the EUT at the specified immunity level for one minute. The test samples were monitored for any degradation in performance. If any degradation of performance occurred, the immunity threshold and error conditions were noted.

### 8.3 Test Results

**Note:** This test was not under scope of the evaluation.

### 8.4 Test Configuration Photograph

Figure 8.1 shows the testing configuration used.

(THIS PAGE INTENTIONALLY LEFT BLANK)

*Figure 8.1 Test Configuration Photograph*

# Intertek Testing Services

---

## 9.0 IEC 61000-4-11, VOLTAGE DIPS AND VOLTAGE INTERRUPTIONS

### 9.1 Test Description

CENELEC Publication 61000-4-11:1994, Electromagnetic Compatibility, Part 4: Testing and Measurement Techniques, Section 11: Voltage Dips, Short Interruptions and Voltage Variations Immunity Tests was the guiding document for this test. This test evaluates the test sample's response to voltage dips and voltage interruptions.

**Table 9.1-1: Voltage interruption levels for different equipment types**

	Standard environment	Industrial Environment	Controlled EM Environment	Portable Equipment
AC Power	1 cycle, each polarity / 100%	0.5 cycle, each polarity / 100%	0.5 cycle, each polarity / 100%	N/A

### 9.2 Test Procedure

The test sample was connected to the test equipment, as shown in Figure 9.1, and monitored for performance. Sequences of three dips/interruptions with intervals of 10 seconds were applied to the EUT's power source at 100% reduction. Abrupt changes in supply voltage occurred at zero crossings of the voltage. The test samples were monitored for any degradation in performance. If any degradation of performance occurred, the immunity threshold and error conditions were noted.

### 9.3 Test Results

**Note:** This test was not applicable because the EUT does not connect to the AC mains.

### 9.4 Test Configuration Photograph

Figure 9.1 shows the testing configuration used.

(THIS PAGE INTENTIONALLY LEFT BLANK)

*Figure 9.1 Test Configuration Photograph*



**10.0 ELECTROMAGNETIC RADIATION DISTURBANCE**

**10.1 Test Description**

CISPR Publications 16 and 16-1 were the guiding documents for this test. This test evaluates the level of the test sample's radiated disturbances to the limits specified in the following tables.

**Radiated Disturbance Limit dB( $\mu$ V/m)**

Class A Radiated Disturbance	
Frequency (MHz)	Quasi-Peak limits in dB ( $\mu$ V/m) at 10m The lower limit shall apply at the transition frequency.
30 to 230	40
230 to 1000	47

Class B Radiated Disturbance	
Frequency (MHz)	Quasi-Peak limits in dB ( $\mu$ V/m) at 10m The lower limit shall apply at the transition frequency.
30 to 230	30
230 to 1000	37

*Note: If the field strength measurement at 10m cannot be made because of high ambient noise levels or for other reasons, measurement of Class B EUT's may be made at a closer distance, for example 3m. An inverse proportionality factor of 20 dB per decade should be used to normalize the measured data to the specific distance for determining compliance. For example, a factor of -10.5 dB should be applied to a reading taken at 3 meters.*

## Intertek Testing Services

---

### 10.2 Test Procedure

Tabletop equipment under test is placed on a non-conductive table that is 0.8 meters above the ground plane. Floor standing equipment under test is elevated above the ground plane with 3 to 12 mm of insulating material. The EUT is placed in the center of a remotely controlled flush-mount, metal-top turntable that is used to rotate the EUT a full 360 degrees. A remotely controlled non-conductive antenna mast is used to scan from one to four meters in height.

### 10.3 Test Results

Initial test results indicated the worst-case radiated disturbance signal to be 10.4 dB below the EN 61326:1998, Class A limit at 891.055 MHz. All other radiated disturbance were at least 13.5 dB below the applicable limits.

Table 10.1 shows that the EUT met the EN 61326:1998, Class A radiated emission requirements of EN 61326.

### 10.4 Test Configuration Photograph

Figures 10.1 and 10.2 show the testing configurations used.

# Intertek Testing Services

---

*Table 10.1: Radiated Disturbance*

**Company:** Fairchild Industrial  
**Model:** TT7800-401  
**Job No.:** J20032025  
**Date:** 11/20/00  
**Standard:** EN 61326  
**Class:** A                      **Group:** 1  
**Notes:**

**Tested by:** Grace Lin  
**Location:** Duluth  
**Detector:** HP8546  
**Antenna:** EMCO3141  
**PreAmp:** None  
**Cable(s):** CABLETW2 CABLEN2  
**Distance:** 10

Ant. Pol. (V/H)	Frequency MHz	Reading dB(uV)	Antenna Factor dB(1/m)	Cable Loss dB	Pre-amp Factor dB	Distance Factor dB	Net dB(uV/m)	Limit dB(uV/m)	Margin dB
V	30.555	8.6	7.5	0.8	0.0	0.0	17.0	40.0	-23.0
V	102.500	6.8	9.3	1.5	0.0	0.0	17.6	40.0	-22.4
V	161.198	7.6	12.2	1.9	0.0	0.0	21.7	40.0	-18.3
V	315.000	5.5	14.3	2.7	0.0	0.0	22.5	47.0	-24.5
V	662.783	8.1	21.2	4.2	0.0	0.0	33.5	47.0	-13.5
V	891.055	8.0	23.5	5.1	0.0	0.0	36.6	47.0	-10.4
Radiated emission was scanned from 30 to 1000 MHz.									

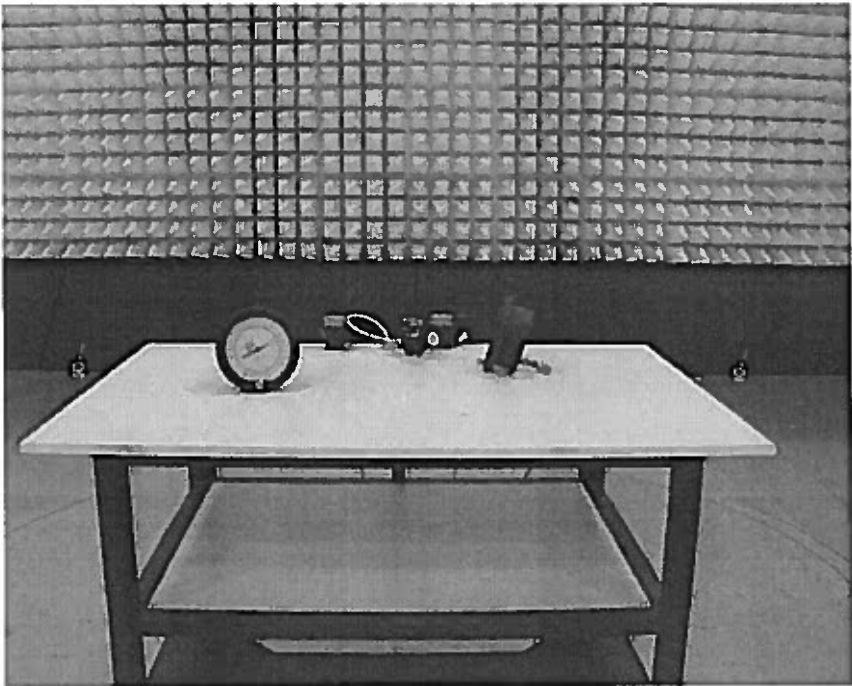

*Figure 10.1 Worst-Case Radiated Emission  
Front View*

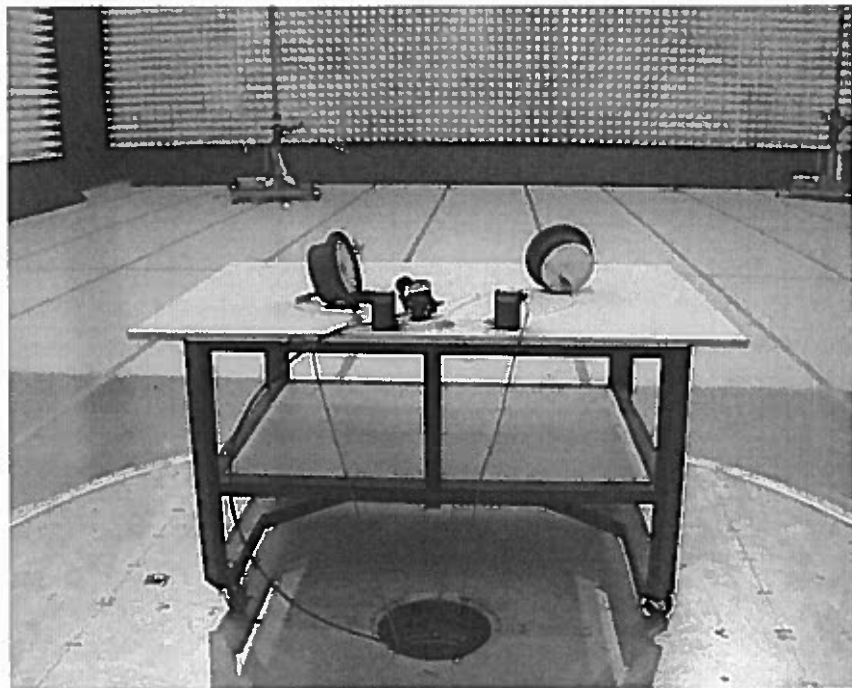

*Figure 10.2 Worst-Case Radiated Emission  
Rear View*

**11.0 AC MAINS LINE-CONDUCTED DISTURBANCE**

**11.1 Test Description**

CISPR Publications 16 and 16-1 were the guiding documents for this test. This test evaluates the level of the test sample's line-conducted disturbances to the limits specified in the following tables.

**Limits for Conducted Disturbance at the Mains Ports**

Class A Line-Conducted Disturbance		
Frequency band MHz	Limit dB( $\mu$ V)	
	Quasi-Peak	Average
0.15-0.50	79	66
0.50-30.0	73	60

*Note: The lower limit shall apply at the transition frequency.*

Class B Line-Conducted Disturbance		
Frequency band MHz	Limit (dB $\mu$ V)	
	Quasi-Peak	Average
0.15-0.50	66 to 56*	56 to 46*
0.50-5.00	56	46
5.00-30.00	60	50

*\* The limit decreases linearly with the logarithm of the frequency in the range of 0.15 MHz to 0.50 MHz.*

*Note: The lower limit shall apply at the transition frequency*

### 11.2 Test Procedure

For AC mains line-conducted emission measurements, a 2 meter x 2 meter vertical conducting surface has been placed 40 cm from the rear of the EUT. The mating surface between the vertical plane and the ground plane is free from slots in excess of 10 inches. The galvanized sheet for the vertical plane is folded over at the bottom edge of the plane, and the spring of the sheet provides constant pressure and contact to the ground plane. Two LISNs are provided for performing AC mains line-conducted emissions.

### 11.3 Test Results

**Note:** This test was not applicable because the EUT does not connect to the AC mains.

### 11.4 Test Configuration Photographs

Figures 11.1 and 11.2 show the testing configurations used.

## Intertek Testing Services

---

*Table 11.1: Conducted Disturbance*

(THIS PAGE INTENTIONALLY LEFT BLANK)



(THIS PAGE INTENTIONALLY LEFT BLANK)

*Figure 11.1 Worst-Case Conducted Emission  
Front View*

# Intertek Testing Services

---

11.2 Worst-Case Conducted Emission

11.2.1 Test Description

Conducted emission test was performed in accordance with CISPR 11 Class B limits. The test was performed in an anechoic chamber. The test results are shown in the following table.

11.2.2 Test Results

The test results are shown in the following table. The test results are in compliance with the CISPR 11 Class B limits.

(THIS PAGE INTENTIONALLY LEFT BLANK)

*Figure 11.2 Worst-Case Conducted Emission*

*Rear View*

### **13.0 EN 61000-3-3, Voltage Fluctuations and Flicker**

#### **13.1 Test Description**

Publication EN 61000-3-3: 1995, Electromagnetic Compatibility, Part 3: Limits – Section 3: Limitations of voltage fluctuations and flicker in low-voltage supply systems for equipment with rated currents less than or equal to 16A, Basic EMC Publication was the guiding document for this test. The objective of this standard is to set limits for voltage fluctuations and flicker emissions.

#### **13.2 Test Procedure**

The HP Harmonic/Flicker Test system is used to monitor the equipment under tests and measure the voltage fluctuations and flicker emissions. The results are recorded and compared to the limits as specified in EN 61000-3-3.

#### **13.3 Test Results**

**Note:** This test was not applicable because the EUT does not connect to the AC mains.