

Ethylene Plant Decoke Valve Automatic Control System

rotork

Publication S150E
Date of issue: 09/99

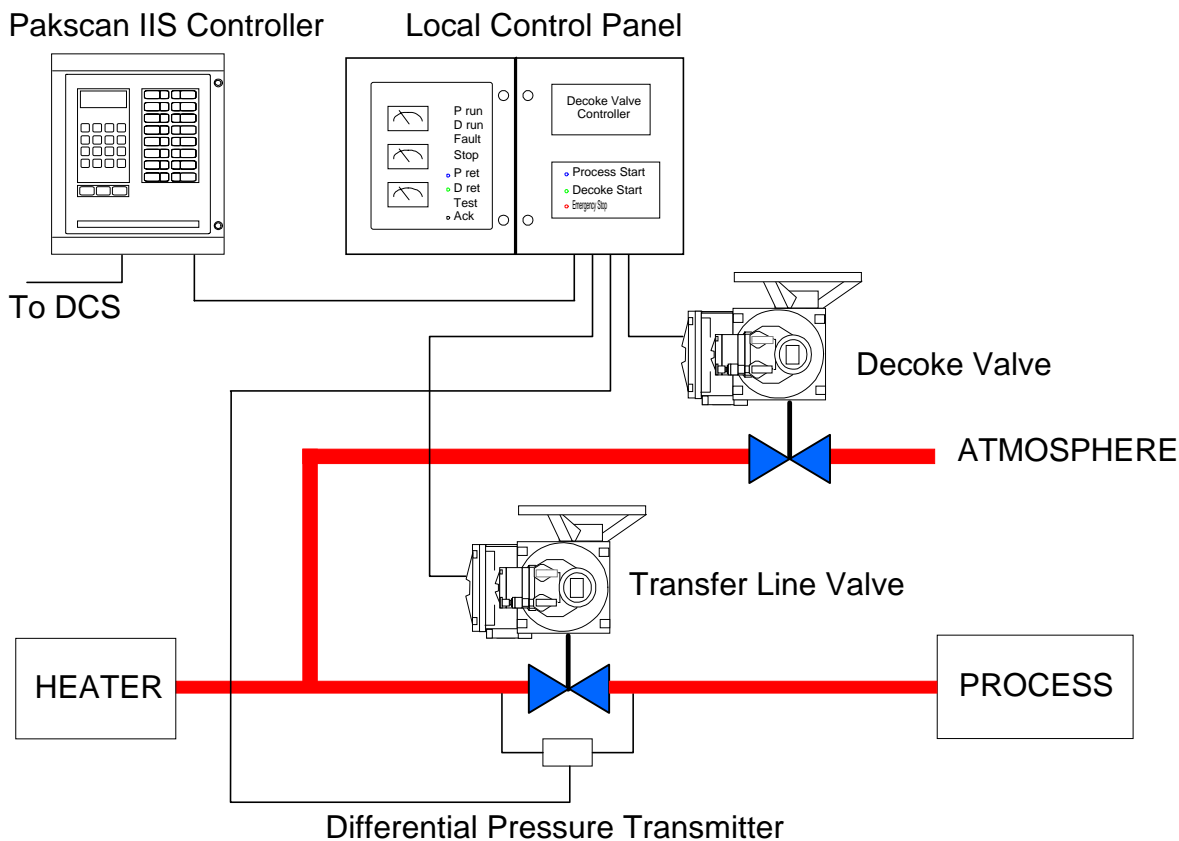

Introduction

Within an ethylene manufacturing process there are heaters that provide energy into the process. These heaters suffer from a phenomenon where deposits of 'coke' accrue on the pipework and valves. This coke is made of carbon granules and can cause flow restrictions for the heater output. From time to time these deposits must be removed, ideally without shutting down the process completely.

In order to perform the decoking operation there are two valves, the transfer line valve and the decoke valve, whose positions must be reversed. The transfer line valve is normally open and must be closed, and similarly the decoke valve which is normally closed must be opened. This operation is quite critical as the process product - ethylene, is a volatile substance and has a low flash point, therefore imposing a fire and explosion risk if it is vented to the atmosphere.

The object of the control system is to perform the closure of the transfer valve and opening of the decoke valve in a safe manner that does not impose a high differential pressure on the transfer valve and yet maintains a positive pressure between the heater and the process.

Because of the temperatures involved and the nature of the coke particles, specialist valves and valve seals are used for the critical valves. The control system also has to protect these parts as far as possible.

Traditionally the decoke and transfer line valves are mechanically joined together so as to ensure that as one opens the other closes. This linkage imposes mechanical constraints on the pipework construction of the plant, the two valves must be alongside each other. If there is a way to remove this constraint then the plant civil construction may be greatly simplified.

Ethylene Plant Decoke Valve Automatic Control System



Publication S150E
Date of issue: 09/99

Zimmermann and Jansen of Düren in Germany are one of the major manufacturers of the valves used for this task. Zimmermann and Jansen, in conjunction with Rotork, have produced an automatic control system that regulates the valve positions to mimic the actions of a mechanical linkage.

This electronic system therefore permits the two valves being controlled to be placed in more convenient locations on the plant than has previously been the case. In addition the electronic system can compensate for varying heater delivery flow rates and alter the valve movement profiles as though a new mechanical linkage had been fitted. The operator therefore benefits with better control and less risk of accident.

Control Requirements

The valve movements have to maintain a positive pressure between the heater and the process at all times. In addition the differential pressure across the transfer line valve must remain within certain tolerances.

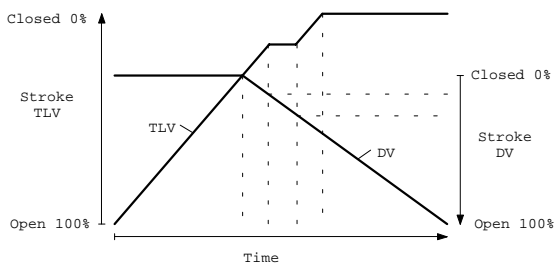

The decoke sequence will result in the decoke valve (DV) finishing in a fully open position and the transfer valve (TLV) being fully closed

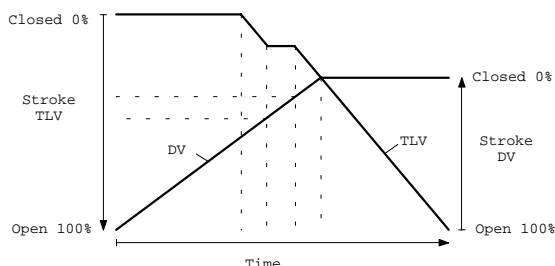

Similarly the process return sequence reverses these positions finishing with the decoke valve closed and the transfer valve fully open.

The critical switching points where the two valves move together may alter if the heater flow rate is above or below the normal value.

Rotork Equipment

The valves are operated by Rotork IQ heavy duty electric actuators. These are suitable for use in hazardous areas such as those around the ethylene plant.

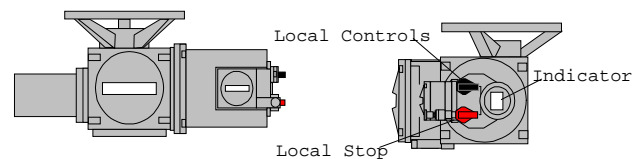

The IQ actuator includes an integral position measurement that accurately reports the valve position. This is critical to the control of the two valves as the position determines the area of the orifice and therefore the differential pressure across the valve.

Each actuator is fitted with a Pakscan field control unit to allow the actuator to be remotely controlled using Rotork's 2 wire control system.

The operation of the whole process is initiated by a plant operator pressing a button to change the valve positions. The operator is provided with a local panel on which there are indications for the valve positions and the status to the control sequences are shown. The operator has a choice of either placing the two valves in the Decoke position or the Process position, or stopping the valves in an emergency.

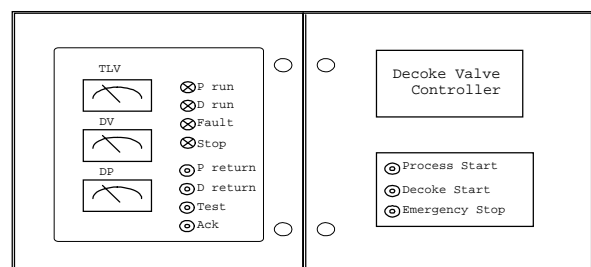

The local panel has a glazed section covering the status indicators.

Ethylene Plant Decoke Valve Automatic Control System



Publication S150E
Date of issue: 09/99

The whole sequence of operation is controlled by a Pakscan IIS master station. This unit acts to move the valves against the preset profile provided by Zimmermann and Jansen.

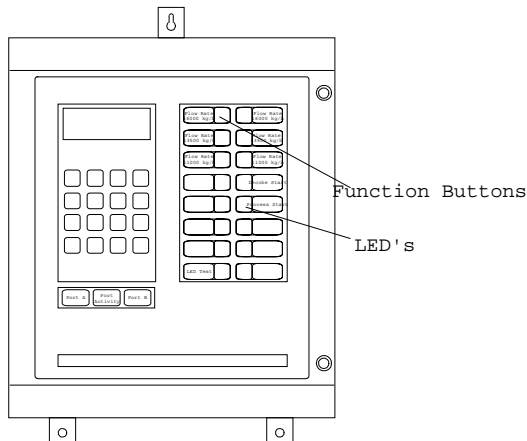

The Pakscan IIS is located in the nearby control room and it is from this unit that the main plant control system (DCS) collects information about the valves and their position.

Because the system uses only 2 wires to interconnect its various parts the installation process is greatly simplified. The local panel is used as a marshalling point in the field and the Pakscan IIS in the control room has only a short distance to connect to the DCS.

Sequence Control

The Pakscan IIS master station contains all the sequence control for the two valves, the lights and the buttons, on one heater decoke valve set.

The sequences are designed to recover in the event of a failure and protection within the system ensures that neither valve can be moved if there is a fault on the system. The operator is informed if a problem exists by the indication lights on the local panel.

The system is able to cater for different flow rates from the heater and selection of the appropriate flow rate is made either directly at the Pakscan IIS master station or via the host system connection prior to the initiation of a primary change-over sequence in the field.

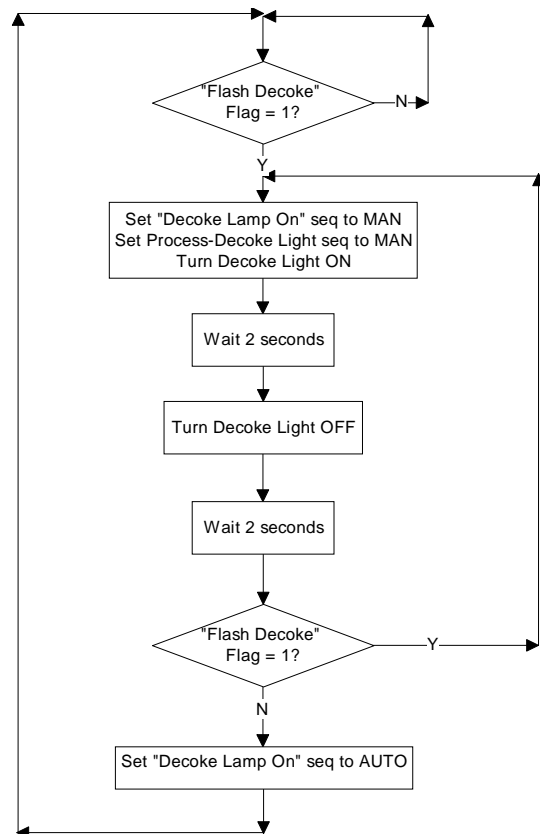

The sequences are programmed into the Pakscan IIS unit using a PC based utility specially designed for use with the Pakscan system.

Host System Connection

The Pakscan IIS master station includes the ability to communicate over a serial link to a supervisory system such as a DCS. This link carries data and information about the valve positions. It is possible to set the system up in a way that permits control of the valve positions from the main DCS screens, though in general the nature of the process demands that control is initiated in the field near to the heater.

The DCS can select and confirm the sequence flow rate profile to be used. It is also used to provide a permissive interlock to ensure that decoke and return to process sequences are initiated at the correct time.

Ethylene Plant Decoke Valve Automatic Control System

rotork

Publication S150E
Date of issue: 09/99

Auxiliary Functions

In some cases the plant equipment includes a differential pressure transmitter placed across the critical Transfer Line valve. This signal cannot be relied upon to deliver accurate information all the time as it is possible for the coke waste to collect in the pipes connecting the transmitter to the process. It is useful as an indication to the operators and the data is displayed on the local panel as well as being sent to the DCS.

Similar additional information can easily be added to the system as the Pakscan IIS system can support up to 32 field units for data collection and control.

Where Quench valves are included in the control scheme, these too may be automated by Rotork actuators and connected to the 2 wire system.

Conclusion

The control of the Decoke process can be easily achieved using this electronic technique. In so doing it removes the design constraint on the engineering of the plant to place the Decoke and Transfer Line valve adjacent to one another. It allows for additional information to be used in the control scheme and, most importantly, it allows the valve sequence to be modified as the heater flow varies.

rotork

UK head office
Rotork Controls Ltd
telephone Bath (01225) 733200
telex (01225) 333467

USA head office
Rotork Controls Inc
telephone Rochester (716) 328 1550
telex (716) 328 5848

As we are continually developing our products, their design is subject to change without notice.

The name Rotork is a registered trade mark

	<i>telephone</i>	<i>telex</i>
AUSTRALIA Ballarat	(0353) 381566	(0353) 381570
CANADA Calgary	(403) 569 9455	(403) 569 9414
CANADA Toronto	(905) 602 5665	(905) 602 5669
CHINA Shanghai	(021) 62787680	(021) 62787681
CHINA (North & Central) Beijing	(10) 64619442/64664433	(10) 64619502
FRANCE Paris	(01) 43 11 15 50	(01) 48 35 42 54
GERMANY Hilden	(02103) 54098	(02103) 54090
HONG KONG & S. CHINA	2520 2390	2528 9746
INDIA Chennai	(044) 6258494/6257107	(044) 6257108
INDONESIA Jakarta	(21) 5806764	(21) 5812623
ITALY Milan	(02) 45703300	(02) 45703301
KOREA (SOUTH) Seoul	(02) 565 4803	(02) 565 4802
MALAYSIA Kuala Lumpur	(03) 2446418/2457443	(03) 2446416
NETHERLANDS Rotterdam	(010) 414 6911	(010) 414 4750
RUSSIA Moscow	(095) 2292463	(095) 2292463
SAUDI ARABIA Al Khobar	(03) 833 0702/1090/1661	(03) 833 9369
SINGAPORE	4571233	4576011
SOUTH AFRICA	(11) 453 9741	(11) 453 9841
SPAIN Bilbao	(94) 676 4244	(94) 676 4864
THAILAND Bangkok	(02) 2593918/2593919	(02) 2593920
USA Houston	(713) 7825888	(713) 7828524
VENEZUELA Caracas	(02) 2653536/2656412	(14) 250822